

**zintrai**<sup>®</sup>  
ACOUSTIC SOLUTIONS

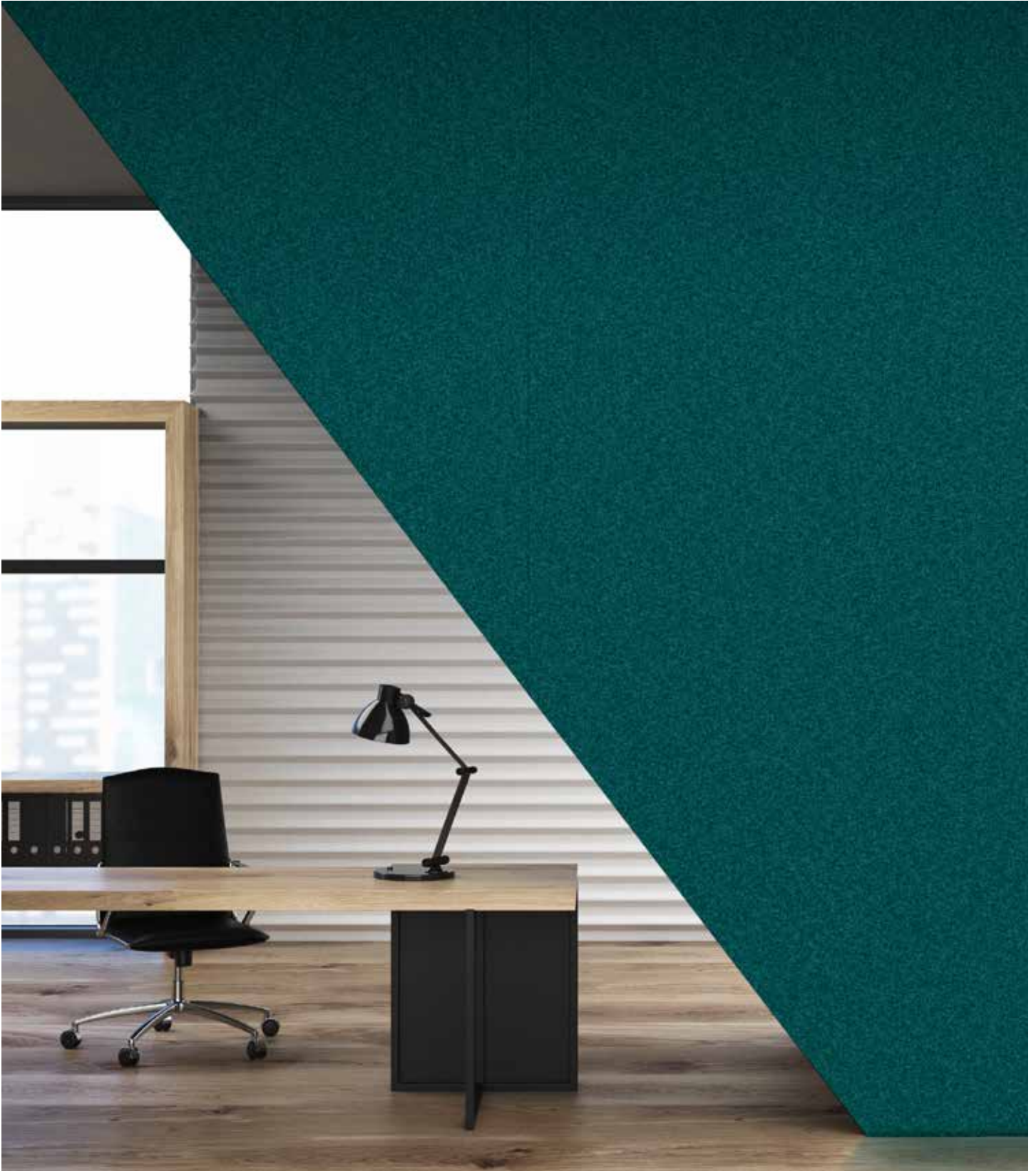

**Goodrich Global**  
Since 1983





2. Zintra Baffles Ridge in Cobalt



# Table of Contents

|                          |     |
|--------------------------|-----|
| <b>Overview</b> .....    | 5   |
| Acoustic Solutions.....  | 7   |
| Benefits.....            | 8   |
| 1/2" (12mm) Sheets.....  | 11  |
| 1/8" (3mm) Sheets.....   | 13  |
| Digital Print.....       | 15  |
| <b>Walls</b> .....       | 19  |
| Plain Tile.....          | 21  |
| Etch.....                | 27  |
| Etch Tile.....           | 31  |
| Patterns.....            | 37  |
| Sliding Screen.....      | 45  |
| Floor to Ceiling.....    | 49  |
| Patterns Tile.....       | 53  |
| Box Tile.....            | 59  |
| Textures.....            | 63  |
| Layers.....              | 67  |
| <b>Ceilings</b> .....    | 75  |
| Quarter Baffles.....     | 77  |
| Box Baffles.....         | 81  |
| Baffle Systems.....      | 85  |
| Individual Baffles.....  | 89  |
| Connect.....             | 93  |
| Clouds.....              | 97  |
| Shapes.....              | 101 |
| <b>Accessories</b> ..... | 105 |
| Concertina.....          | 107 |
| Desk Wrap.....           | 111 |
| Desk Dividers.....       | 115 |
| Desk Screen.....         | 119 |
| Desk Modesty.....        | 123 |
| <b>Hardware</b> .....    | 127 |





# Zintra Overview



6. Zintra Pattern Shard in Ivory on Sunshine backer

# Zintra Acoustic Solutions



Zintra Connect Rise in Slate  
Zintra Pattern Wamika in Pewter on Slate backer

Zintra is the ideal material for absorbing internal and external sounds, reducing the noise level in a space. Available in a wide range of colors and designs, used for a variety of applications at an affordable price. Our standard product line offers countless combinations of acoustic solutions sure to deliver on style and function.

# Zintra Benefits

## WHAT ARE THE BENEFITS OF ADDING AN ACOUSTIC SOLUTION TO YOUR SPACE?



**1.** Reduce echos, background noise and reverberations



**3.** Improve the peacefulness of your room



**2.** Improve sound quality for clear conversations



**4.** Improve the aesthetics of your space

## What is an Alpha-w rating?

Alpha-w (Aw) is short Weighted Sound Absorption Coefficient and is a measurement of how much sound a surface absorbs. An acoustic solution's performance is measured using this rating.

## What is an NRC Rating?

NRC is short for noise reduction coefficient and is a measurement of how much sound a surface absorbs. An acoustic solution's performance is measured using this rating.

## NRC and Alpha-w Ratings range from:



to



A zero rating means a material **absorbs 0%** of the sound energy that reaches the material. **Reflects 100% back.**

A one rating means a material **absorbs 100%** of the sound energy that reaches the material. **Reflects 0% back.**



**zintr**<sup>®</sup>

NOISE REDUCTION DEPENDING  
ON PRODUCT CONFIGURATION

**NRC /  
Aw 0.0**

**NRC 0.02  
Aw 0.02**  
brick or concrete wall

**NRC 0.05  
Aw 0.05**  
standard drywall

**NRC 0.4  
Aw 0.3**

**NRC 0.9  
Aw 0.95**

**ZINTRA** ▶ ◀ **WALL**



Zintra acoustic solutions  
mounted directly to the wall  
**NRC 0.45 / Aw 0.3**

**ZINTRA** ▶ ◀ **WALL**



Zintra acoustic solutions mounted  
2" (50mm) away from the wall  
**NRC 0.8 / Aw 0.75**

**ZINTRA** ▶ ◀ **WALL**



Zintra acoustic solutions mounted  
6" (150mm) away from the wall  
**NRC 0.9 / Aw 0.95**



10. Zintra 1/2" (12mm) Sheet Colors

# Zintra 1/2" (12mm) Sheets



Zintra 1/2" (12mm) Sheet in Brick

Ideal for walls, ceilings, screens, partitions and millwork. 1/2" (12mm) Sheets are easily fabricated and installed to offer the simplest acoustic solution. Large 48" x 110" (1225mm x 2800mm) are easily cut to size.

Fire Rating: ASTM-E84 – Class A classification | AS ISO 9705 – 2003 – Group 1 classification | EN-13501 – B-s2-d0 classification

## COLOR OPTIONS:





# Zintra 1/8" (3mm) Sheets



Zintra 1/8" (3mm) Sheet in Charcoal

Zintra 1/8" (3mm) Sheets are an acoustic solution developed in an easy to manipulate thickness perfect for use as wrapped panels or on curved surfaces. The large 48" x 110" (1225mm x 2800mm) Sheets work perfectly as a seamless floor to ceiling wall covering.

## 1/8" (3MM) COLOR OPTIONS:

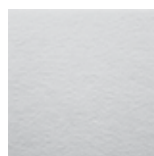

SNOW



CLOUD



DOVE



CHARCOAL



SHADOW



14. Zintra Digital Print custom image

# Zintra Digital Print



Zintra Digital Print custom image

Combine the performance of a cost effective and sound absorbing solution with digital printing to create your design vision. Ideal for reinforcing branding, way-finding and corporate identity.



Zintra Digital Print custom image

## DIGITAL PRINT SPECIFICATIONS

Dimensions: 48" (1220mm) w x 108" (2745mm) h x 1/2" (12mm) d  
NRC Rating: 0.45 – 0.90 (See pages 8-9)  
Aw Rating: 0.30 – 0.95 (See pages 8-9)  
Digital Imaging: Zintra can be printed using UV inks  
Notes: Custom sizes available





Zintra Digital Print custom image



Zintra Digital Print custom image





# Zintra Walls



20. Zintra Plain Tile Hourglass in Brick Linen and Ecu

# Zintra Plain Tile



Zintra Plain Tile Trapezium in Smoke and Sunshine

Have some creative fun by mixing and matching Zintra Plain Tiles 24 colors and 13 shapes. Install as either wall to wall or as feature artwork to create an option suitable for any commercial, education or hospitality environment.

## BATTLEAXE

Available in boxes of 13

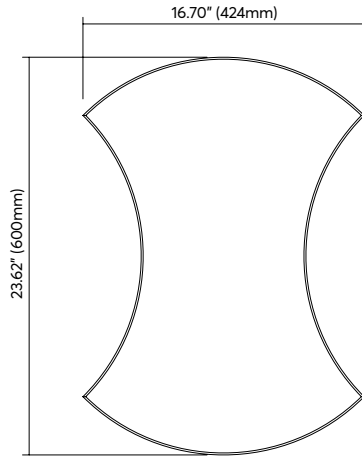

Front View

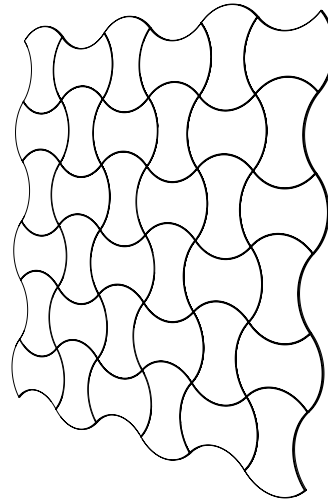

36 Tile Assembly

## CHEVRON

Available in boxes of 10

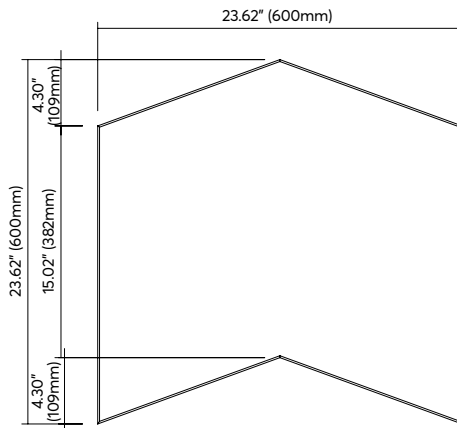

Front View

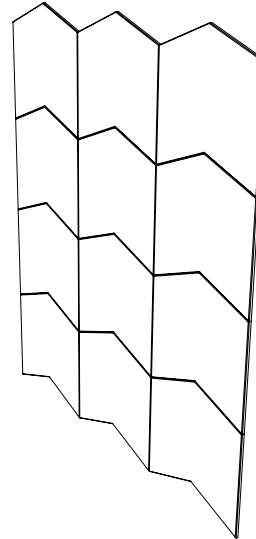

12 Tile Assembly

## DIAMOND

Available in boxes of 20

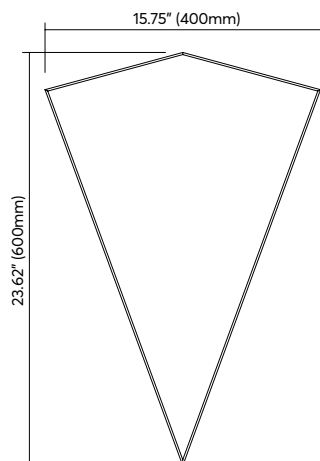

Front View

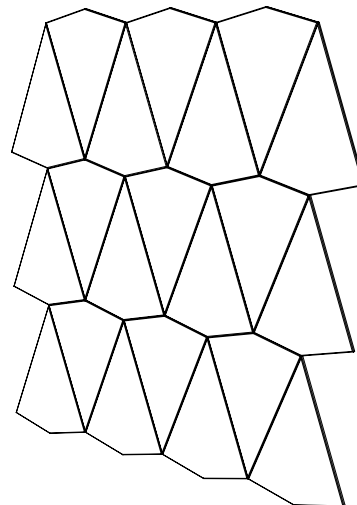

21 Tile Assembly

# GEOMETRICS

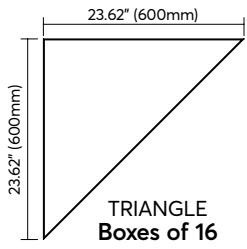

**TRIANGLE**  
Boxes of 16

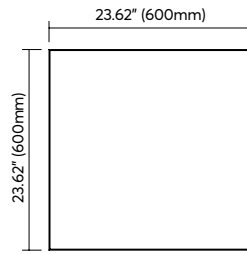

**SQUARE**  
Boxes of 8

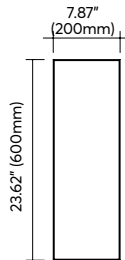

**PLANK**  
Boxes of 26

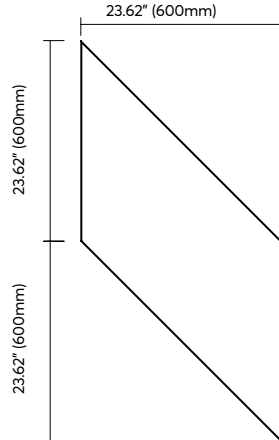

**PARALLELOGRAM**  
Boxes of 4

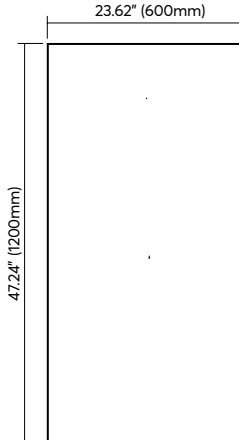

**RECTANGLE**  
Boxes of 4

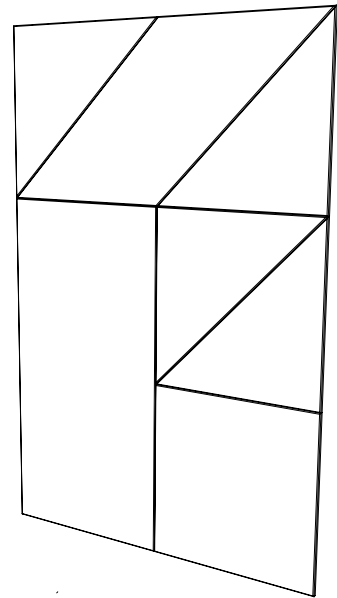

**7 Tile Assembly**

# HERRINGBONE

Available in boxes of 12

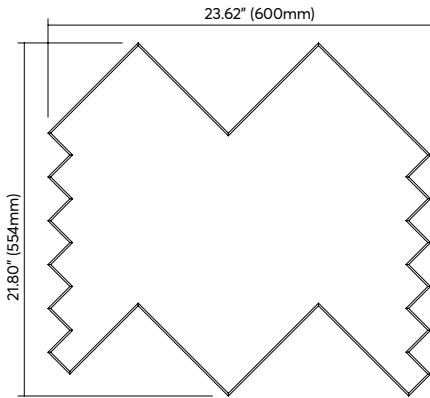

**Front View**

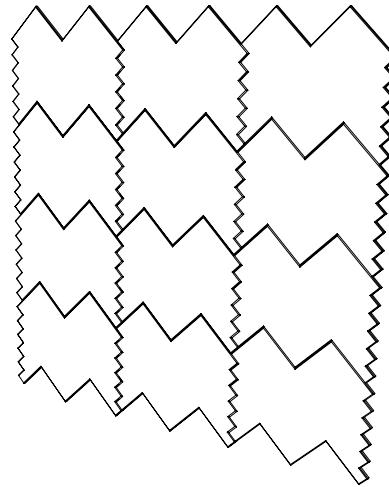

**12 Tile Assembly**

# HEXAGON

Available in boxes of 10

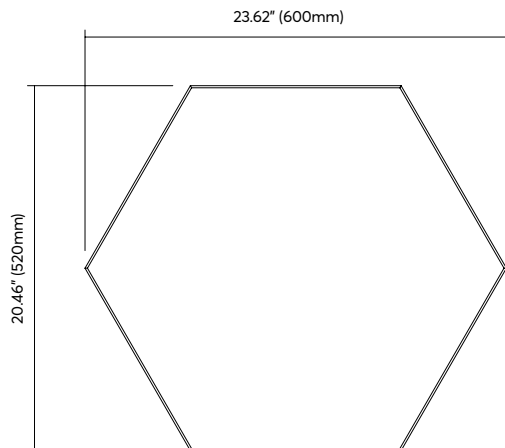

**Front View**

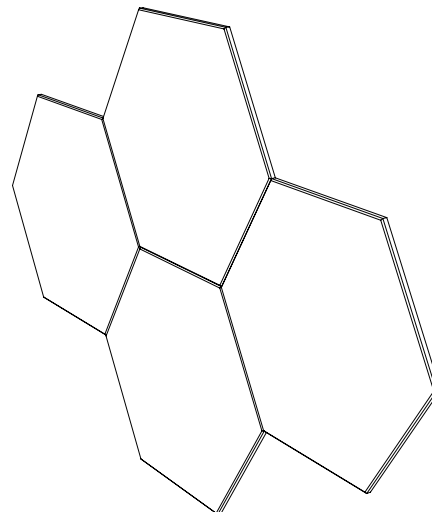

**4 Tile Assembly**

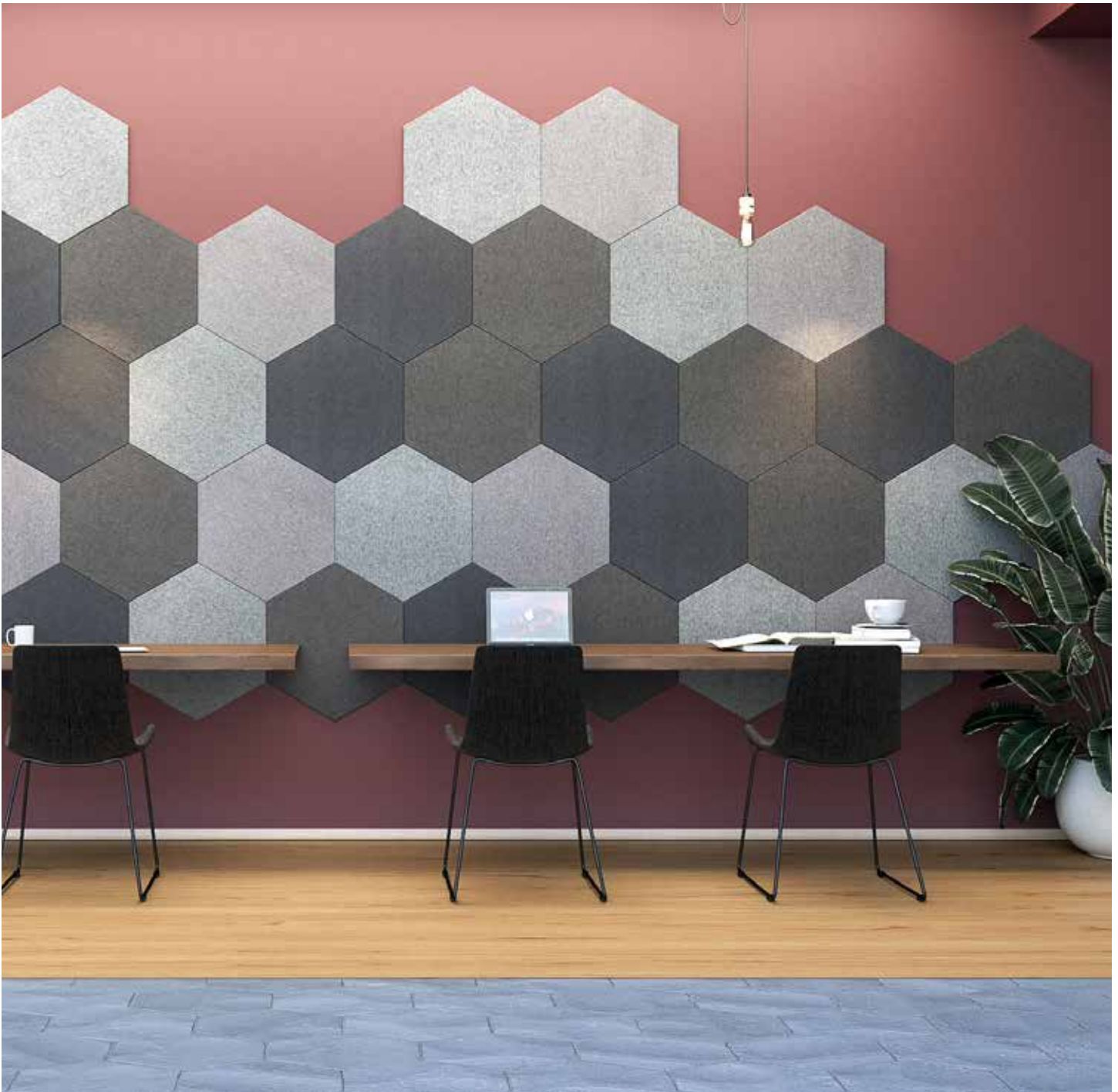

Zintra Plain Hex Tiles in Pebble, Fossil, Chambray and Pewter

## PLAIN TILES SPECIFICATIONS

- Dimensions: See pages 22-25
- Thickness: 1/2" (12mm)
- Colors: Available in all 24 colors (See page 11)
- NRC Rating: 0.45 (See pages 8-9)
- Aw Rating: 0.30 (See pages 8-9)
- Notes: Custom sizes available

For complete specification and installation information, visit [zintraacoustic.com](http://zintraacoustic.com)

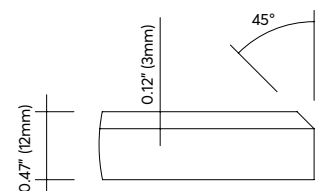

Typical Edge Detail



# HOURGLASS

Available in boxes of 5

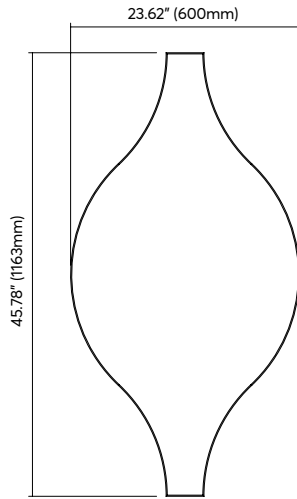

Front View

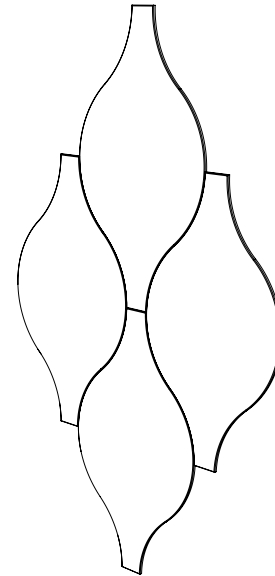

4 Tile Assembly

# JIGSAW

Available in boxes of 8

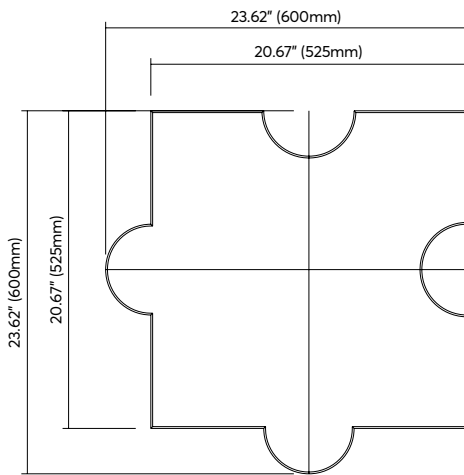

Front View

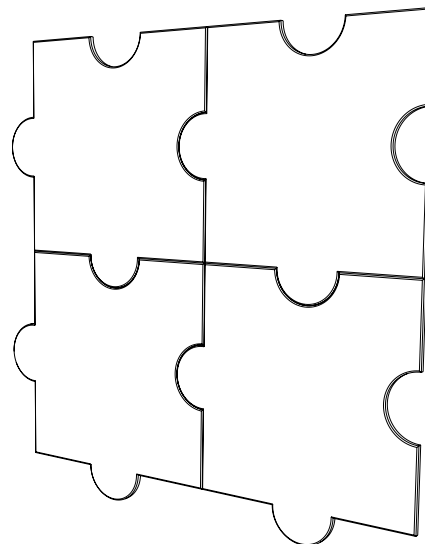

4 Tile Assembly

# TRAPEZIUM

Available in boxes of 15

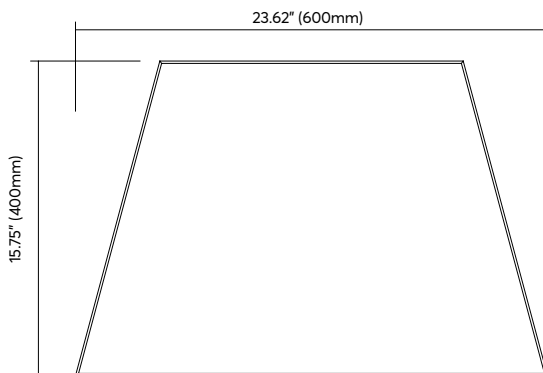

Front View

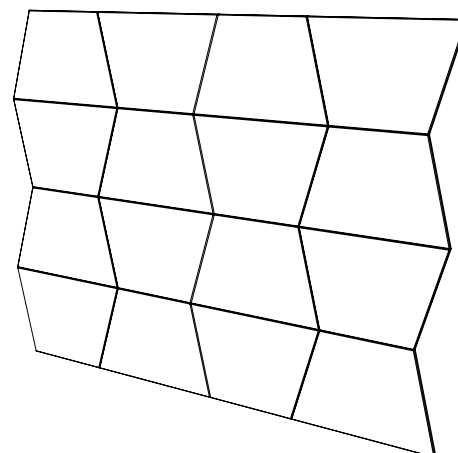

16 Tile Assembly

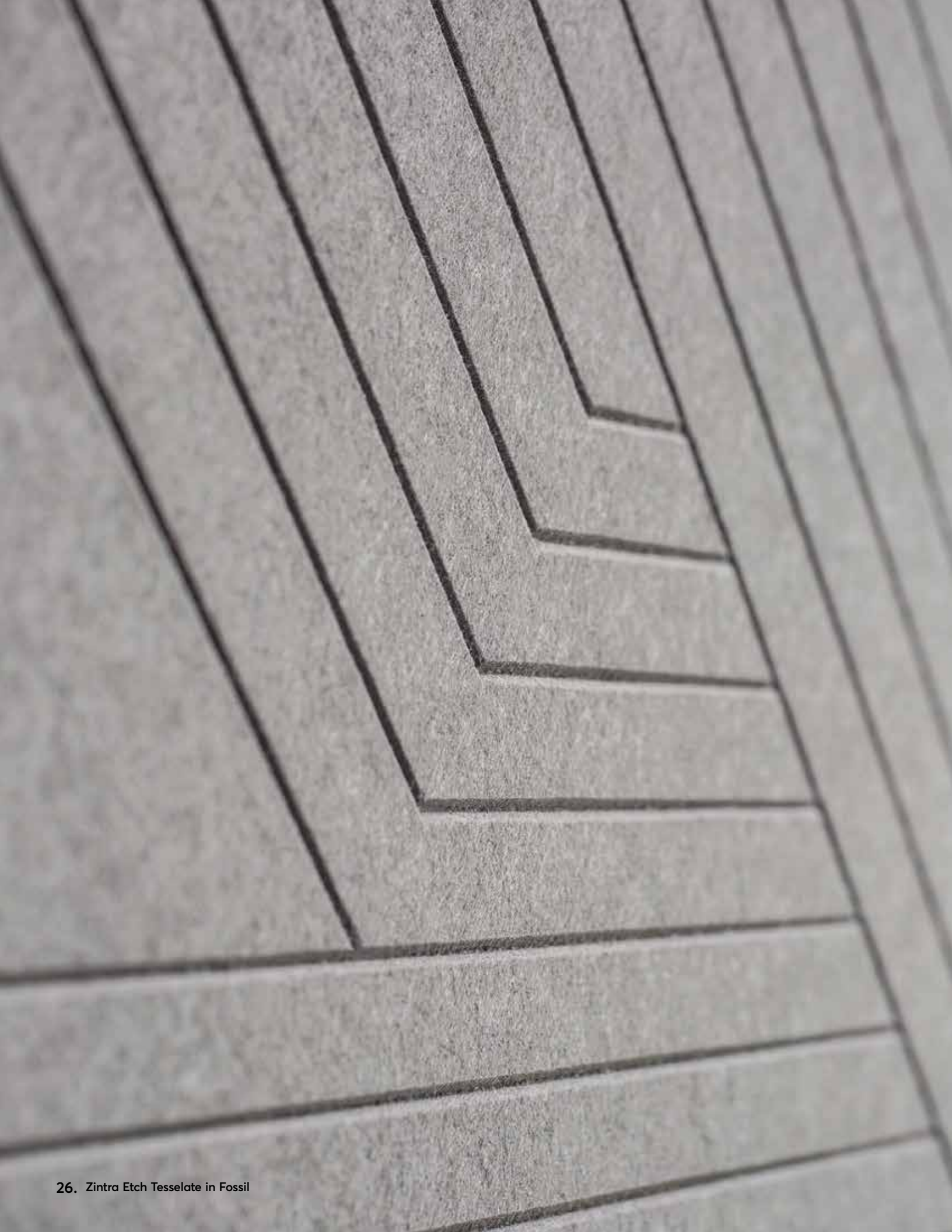



Zintra Etch Tetris in Ecru

Acoustic absorption meets dynamic 3D design with a range of subtle etched patterns. Using a shallow V-groove cut, each Etch pattern delivers a distinctive look to walls or ceilings.



Zintra Etch Tessellate in Fossil

## ETCH SPECIFICATIONS

Dimensions: 48" (1220mm) w x 108" (2745mm) h x 1/2" (12mm) d  
 Colors Available in all 24 Zintra 1/2" (12mm) sheet colors (See page 11)  
 NRC Rating: 0.45 – 0.90 (See pages 8-9)  
 Aw Rating: 0.30 – 0.95 (See pages 8-9)  
 Notes: Custom sizes available  
 For complete specification and installation information, visit [zintraacoustic.com](http://zintraacoustic.com)

## V-Groove detail view

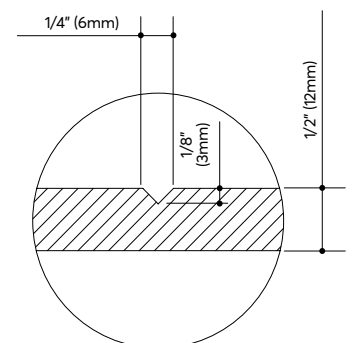

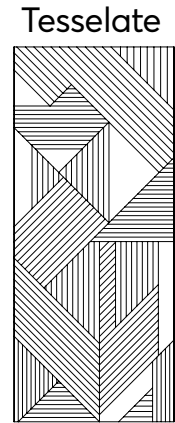
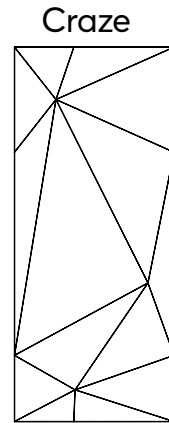
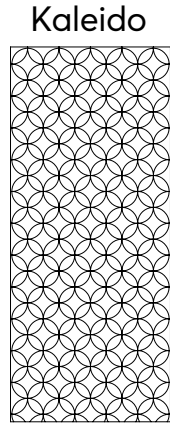
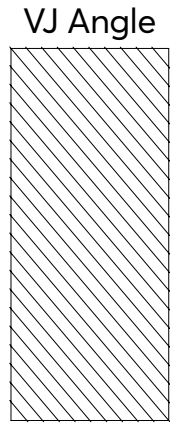
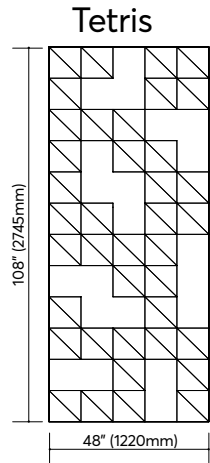

**Reed Bed**

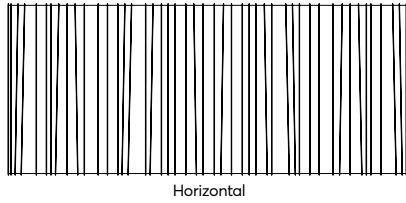
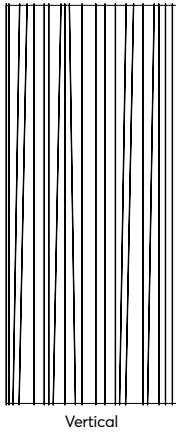

Vertical

**VJ Board Narrow**

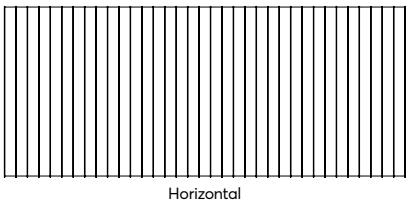
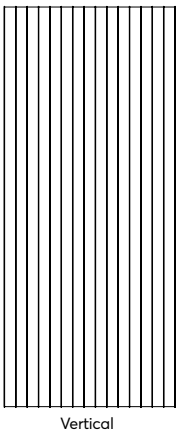

Vertical

**VJ Board Wide**

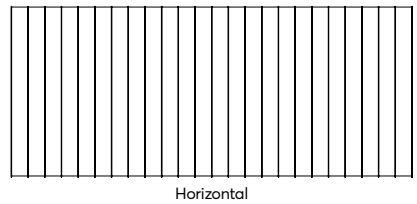
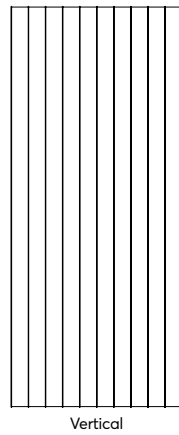

Vertical

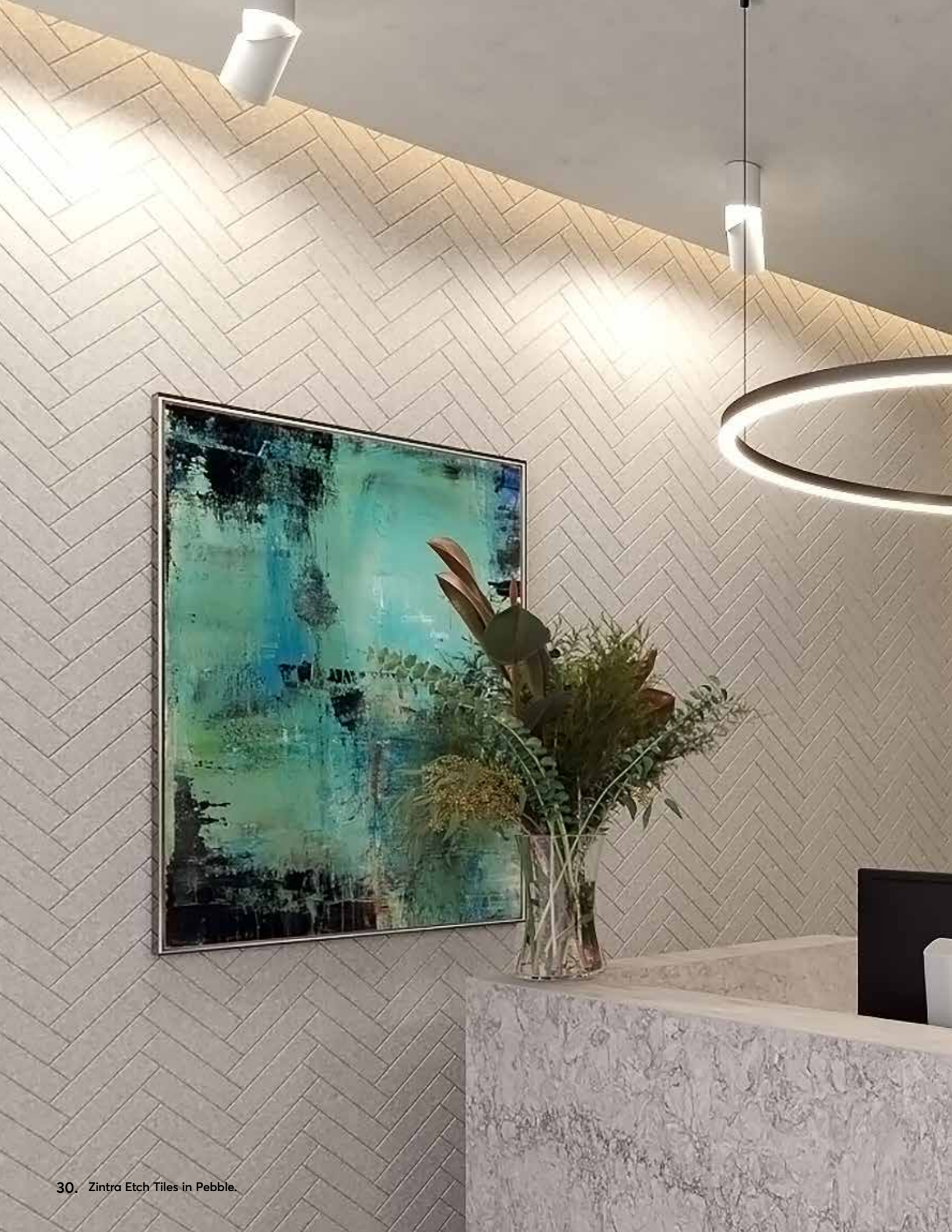

# Zintra Etch Tile



Zintra Etch Tiles Circle in Midnight

Zintra Etch Tile utilises the timeless shallow v cut to create ten sophisticated and contemporary patterns in a convenient format extension to the Zintra Etch range. Mix and match the designs with 24 colors for ultimate flexibility installed as either wall to wall or feature.

## BATTLEAXE

Available in boxes of 13

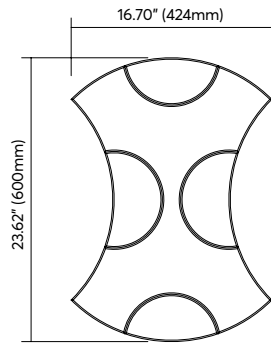

Front View

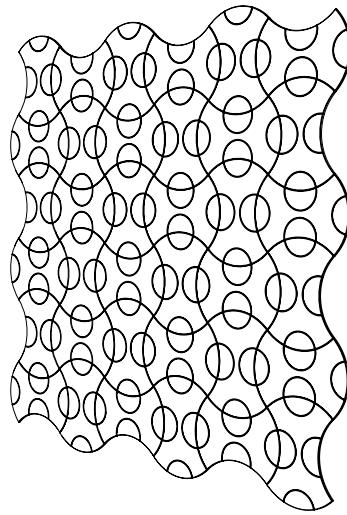

36 Tile Assembly

## CHEVRON

Available in boxes of 10

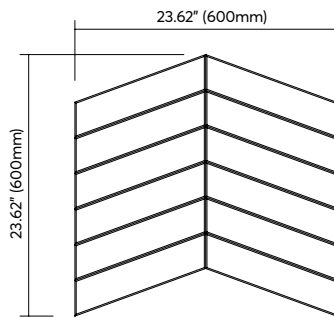

Front View

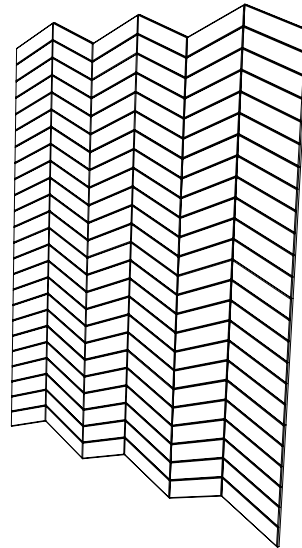

12 Tile Assembly

## DIAMOND

Available in boxes of 20

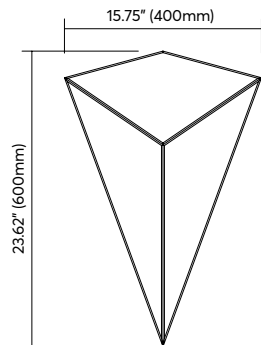

Front View

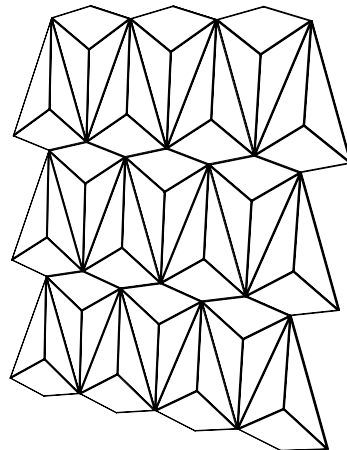

21 Tile Assembly



## HERRINGBONE

Available in boxes of 12

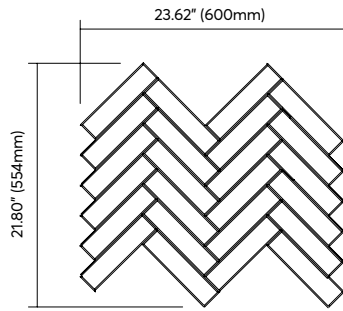

Front View

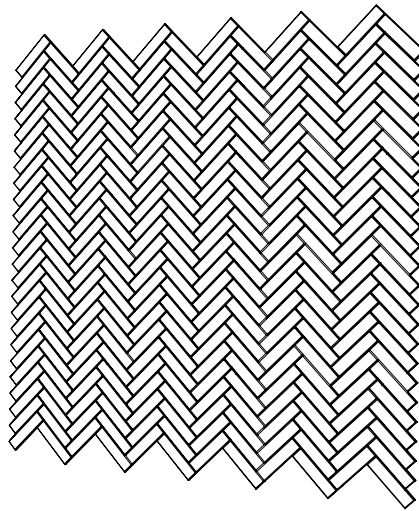

12 Tile Assembly

## HEXAGON

Available in boxes of 10

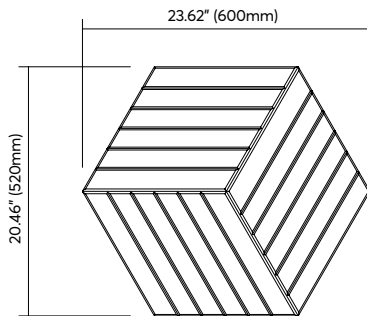

Front View

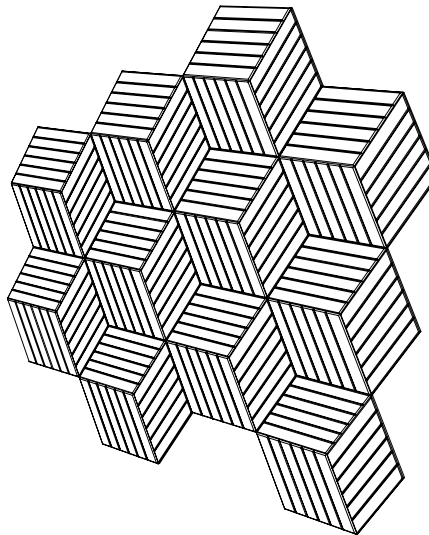

11 Tile Assembly

## HOURLASS

Available in boxes of 5

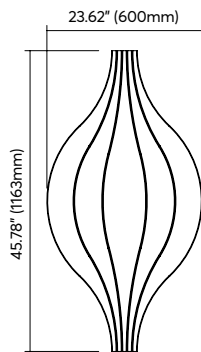

Front View

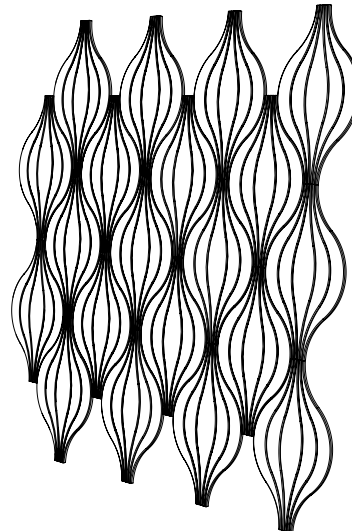

20 Tile Assembly



Zintra Etch Tiles Planks in Cobalt

**ETCH TILES SPECIFICATIONS**

- Dimensions: See pages 32-35
  - Thickness: 1/2" (12mm)
  - Colors: Available in all 24 colors (See page 11)
  - NRC Rating: 0.45 (See pages 8-9)
  - Aw Rating: 0.30 (See pages 8-9)
  - Notes: Custom sizes available
- For complete specification and installation information, visit [zintraacoustic.com](http://zintraacoustic.com)

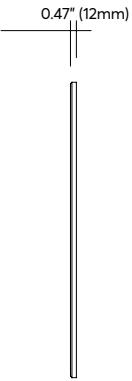

Side View

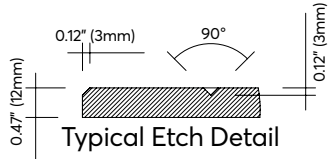

Typical Etch Detail

## PLANK

Available in boxes of 26

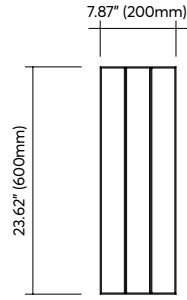

Front View

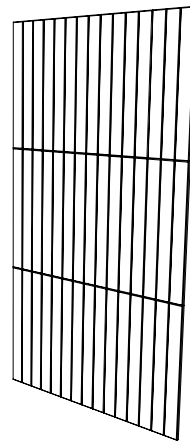

15 Tile Assembly

## SQUARE

Available in boxes of 8

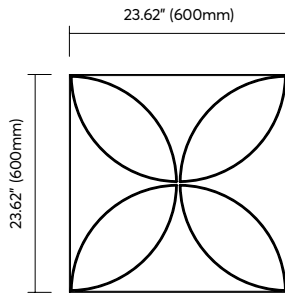

Front View

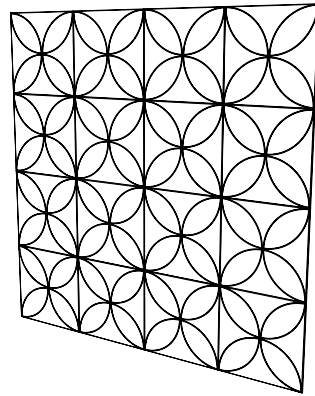

16 Tile Assembly

## TRAPEZIUM

Available in boxes of 15

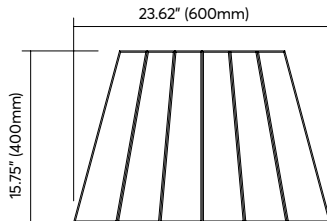

Front View

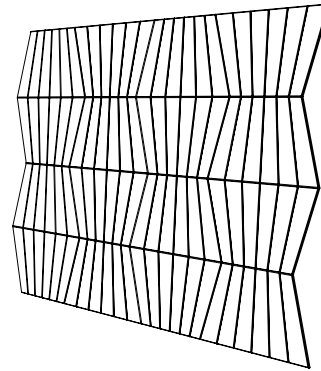

16 Tile Assembly

## TRIANGLE

Available in boxes of 16

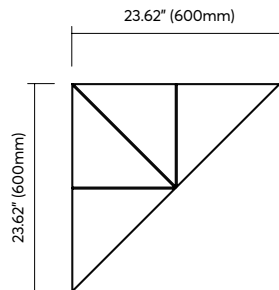

Front View

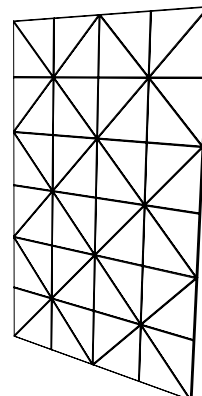

12 Tile Assembly



# Zintra Patterns



Zintra Pattern Sutra in Fossil on Linen backer

Zintra Patterns offer virtually unlimited style options to walls, dividers and ceilings. Patterns can also be paired with a solid Zintra backing panel to add even more color, depth and texture while increasing the NRC / Alpha-w value.

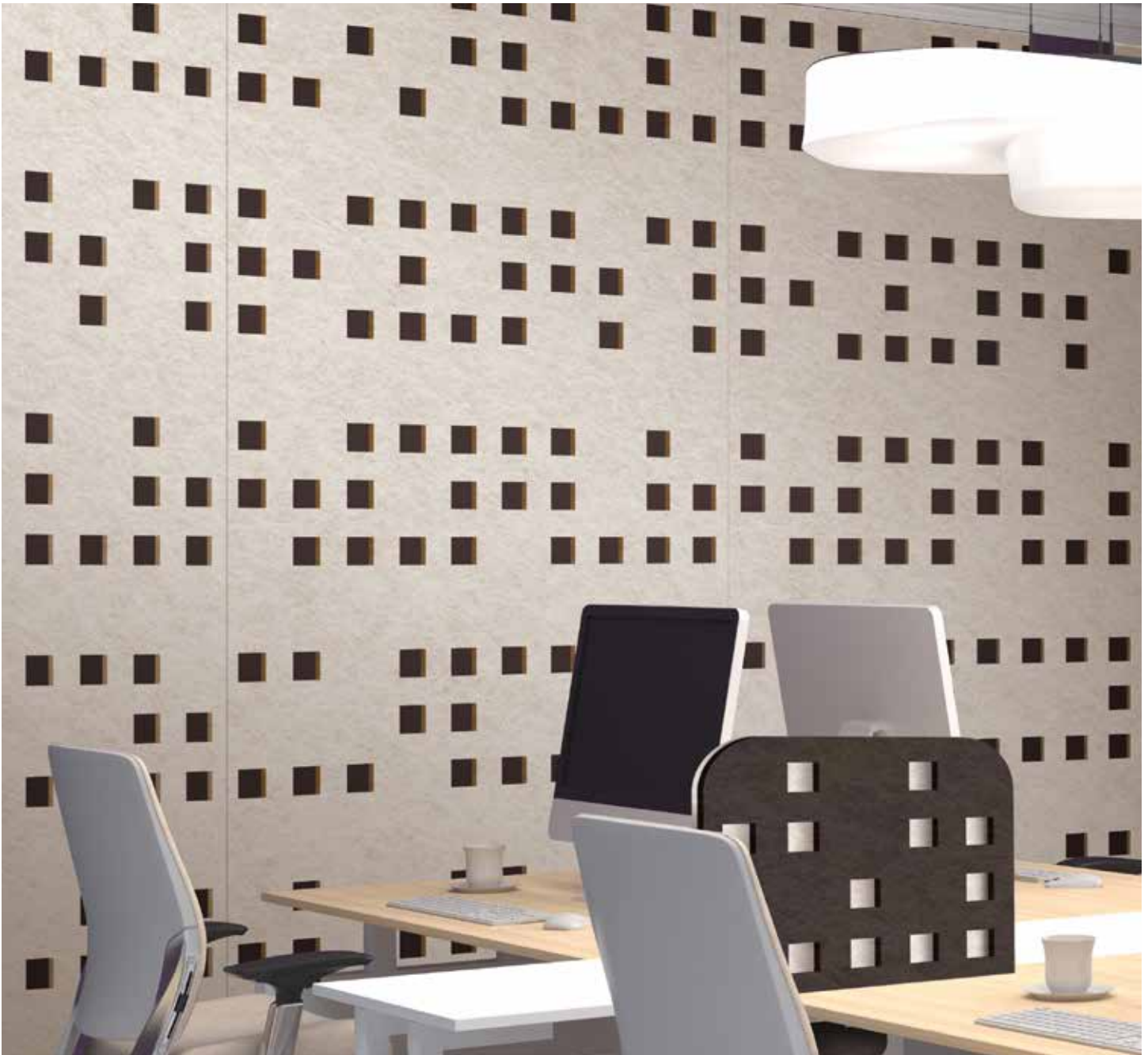

Zintra Pattern Pixel in Linen on Cocoa backer

## PATTERNS SPECIFICATIONS

- Dimensions: 23.8" (603mm) x 23.8" (603mm)  
23.8" (603mm) w x 47.8" (1213mm)  
48" (1220mm) x 108" (2745mm)
- Thickness: 1/2" (12mm) – Pattern Layer only  
1" (24mm) – Pattern Layer + Backer
- Colors: Available in all 24 colors (See page 11)
- NRC Rating: 0.45 – 0.90 (See pages 8-9)
- Aw Rating: 0.30 – 0.95 (See pages 8-9)
- Notes: Custom sizes available

For complete specification and installation information, visit [zintraacoustic.com](http://zintraacoustic.com)

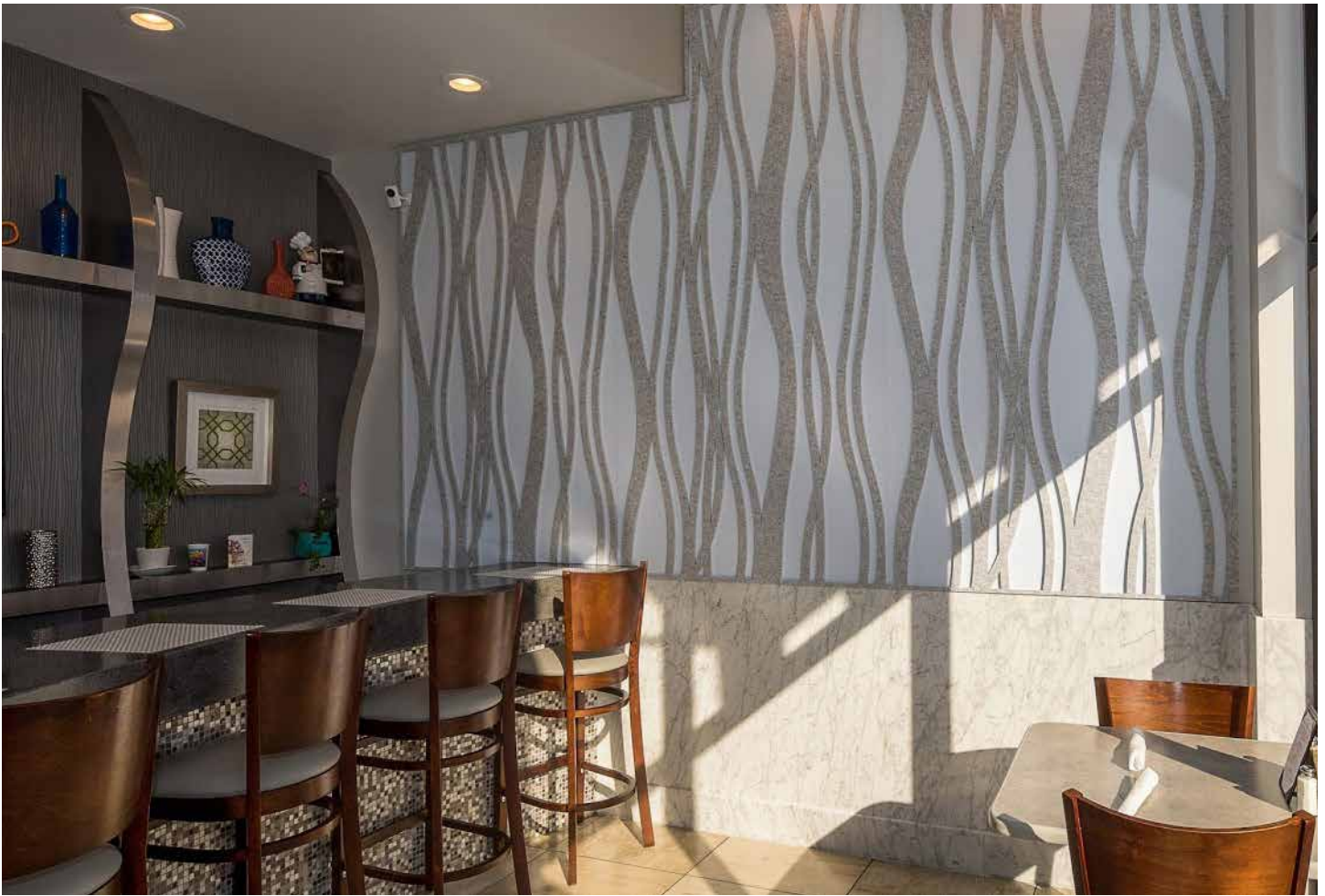

Zintra Pattern Mandava in Smoke on Frost backer



Zintra Pattern Fishbone in Greige on Sky backer



Zintra Pattern Setro in Slate on Chambray backer

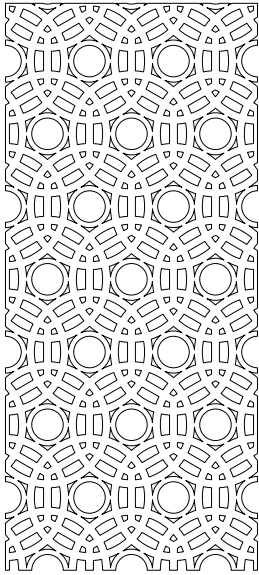

Abhaya

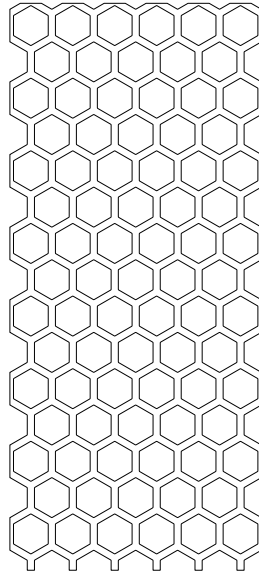

Asiatic

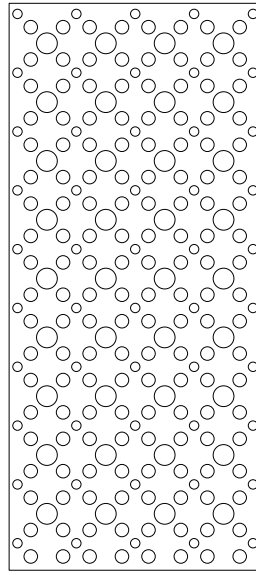

Astra

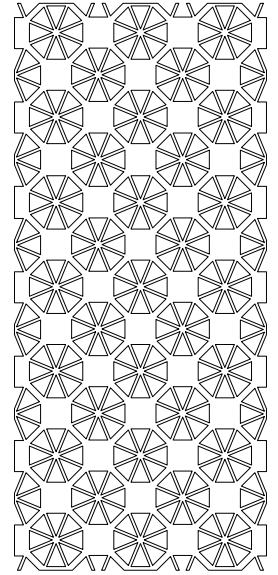

Bengal

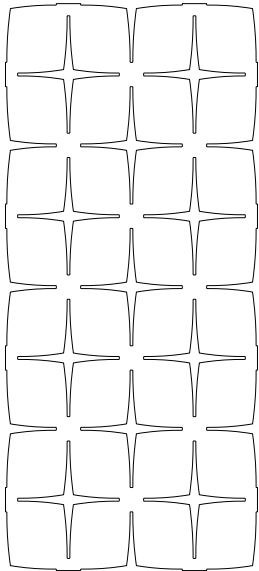

Devraj

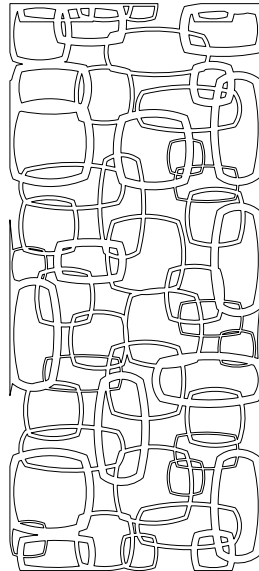

Elephanta

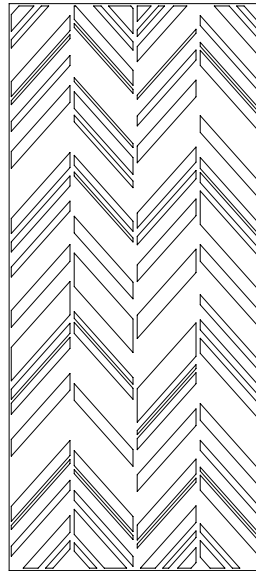

Fishbone

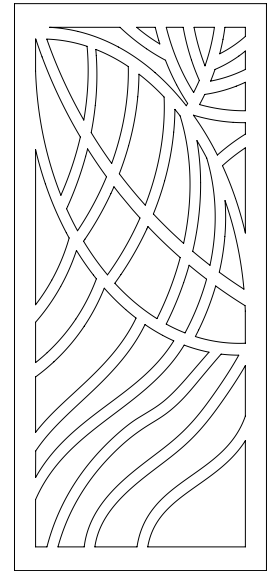

Foliage

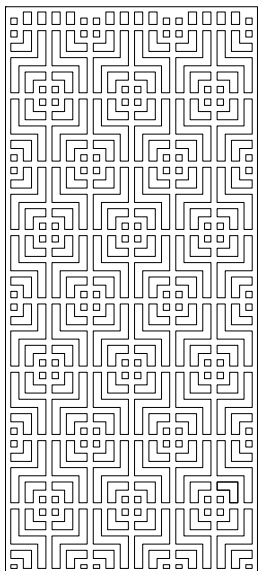

Indus

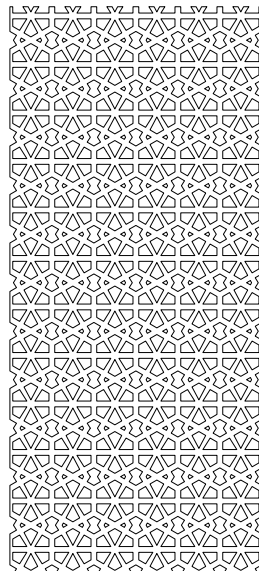

Kali



Kerala

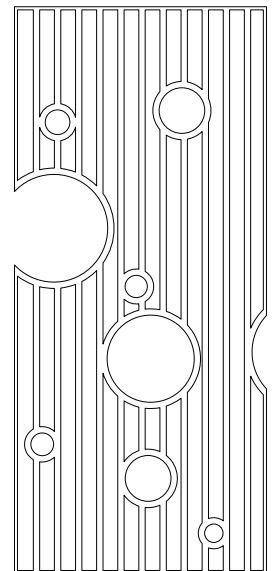

Krishnan



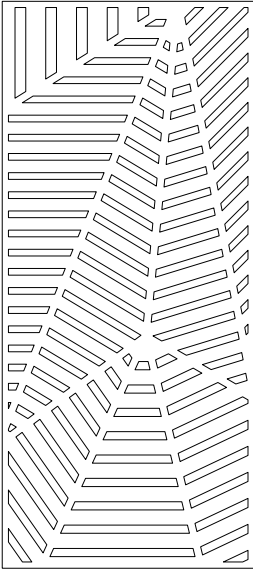

Bhushan

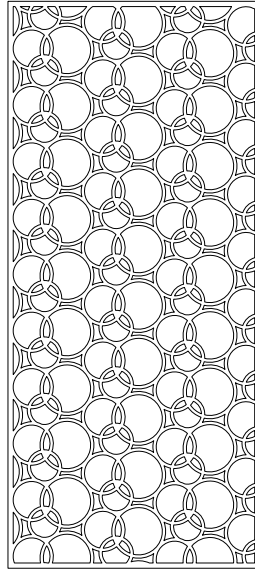

Bharata

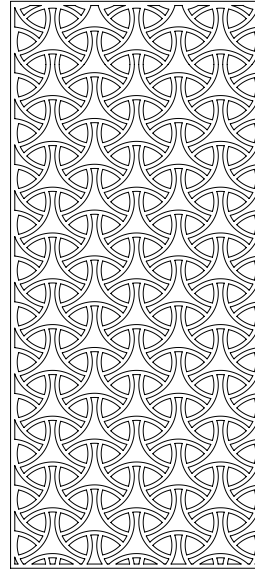

Cirque

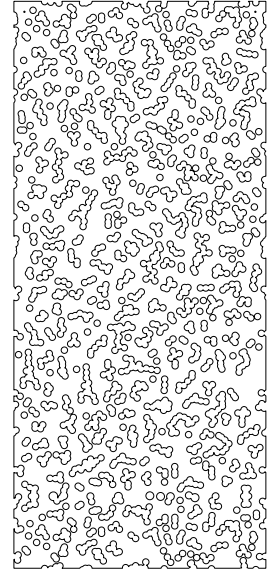

Deepak

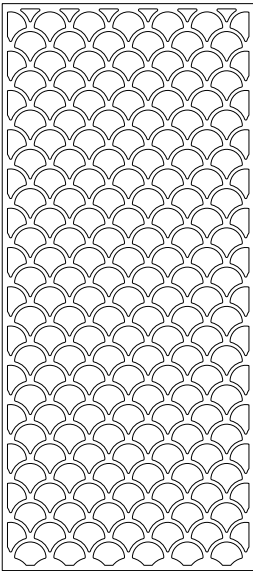

Gadiva



Ginkgo

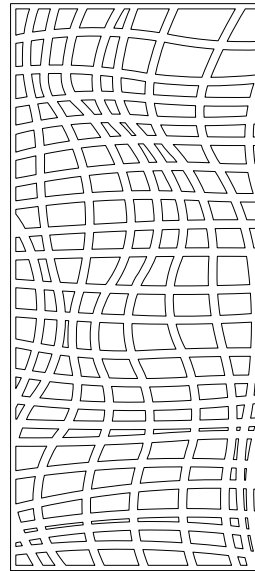

Haimati

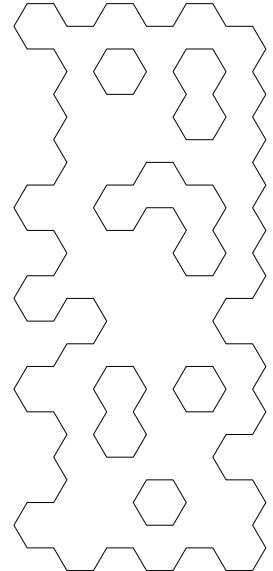

Hex

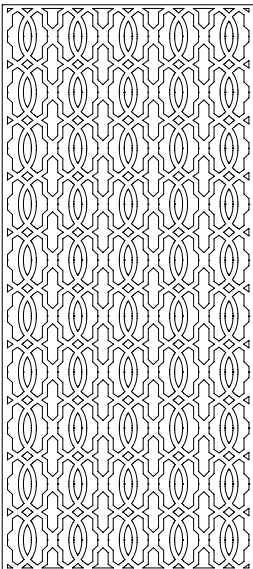

Links

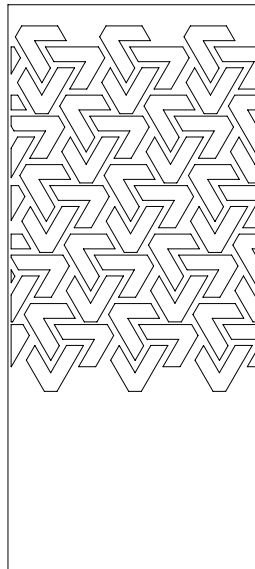

Lost

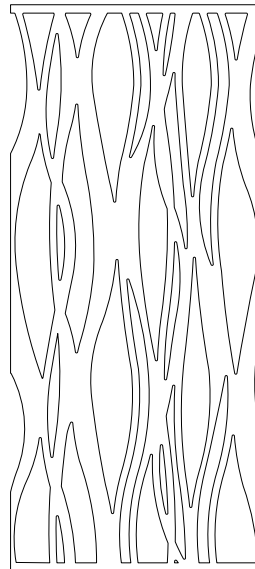

Mandava

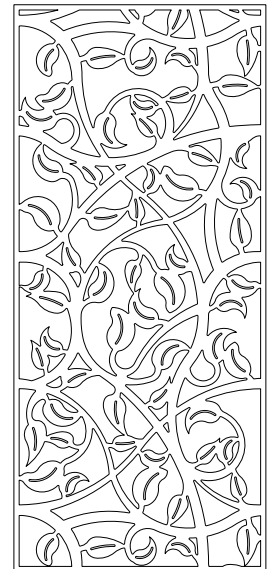

Malin

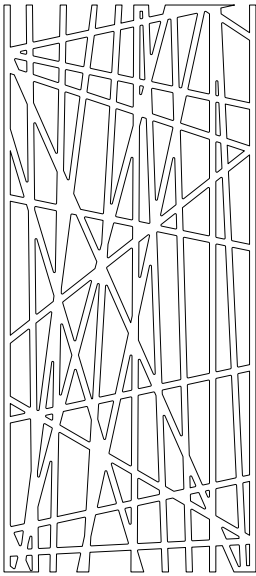

Monsoon

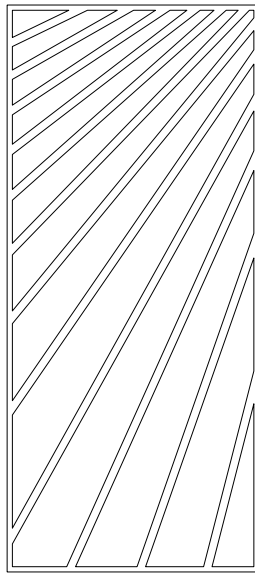

Nadu

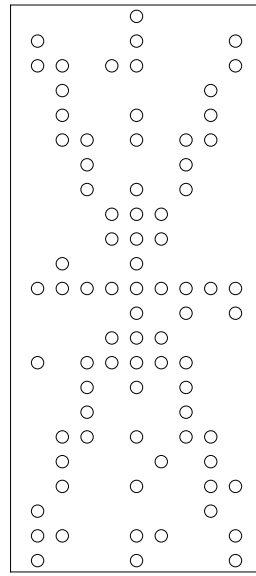

Noktalar

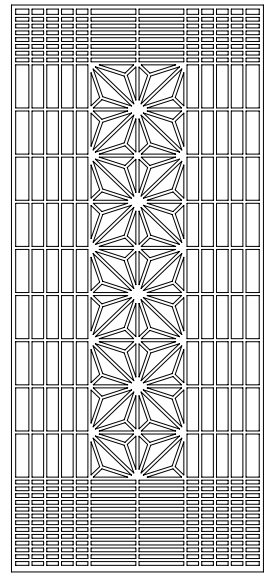

Origami

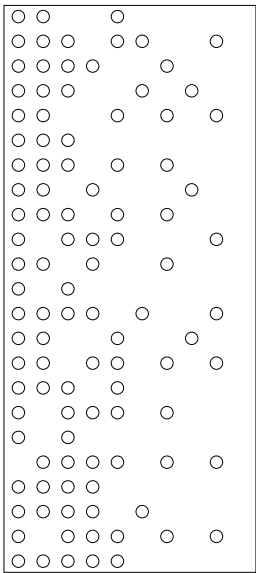

Punto

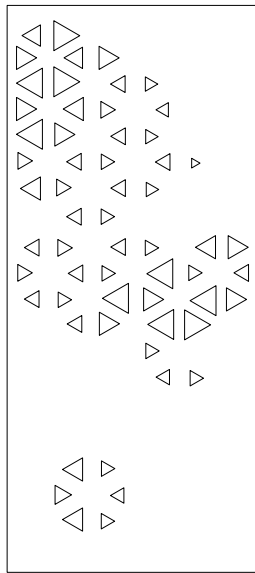

Prose

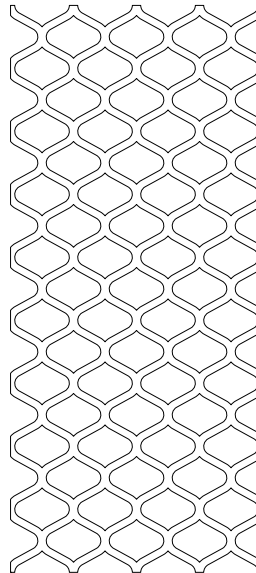

Raja

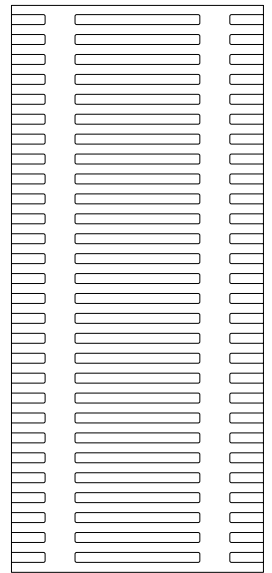

Sakra

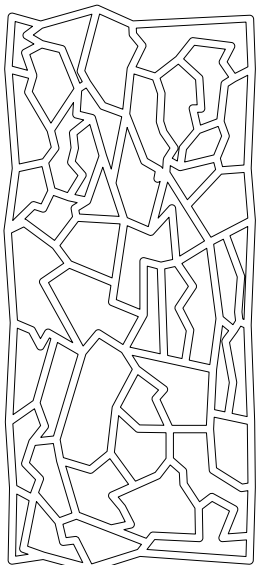

Siptical

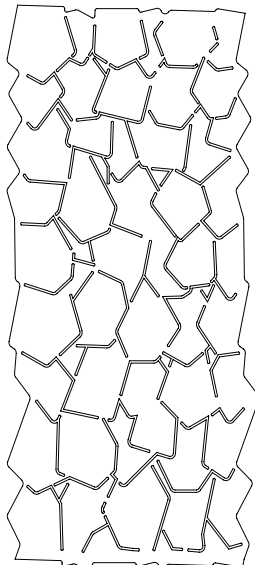

Stone age

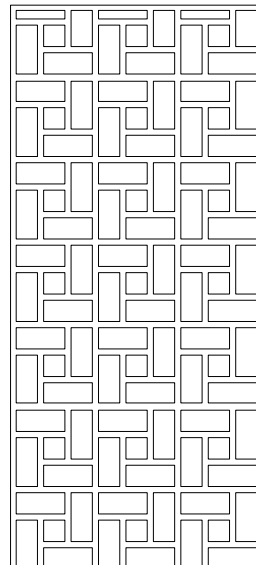

Sutra

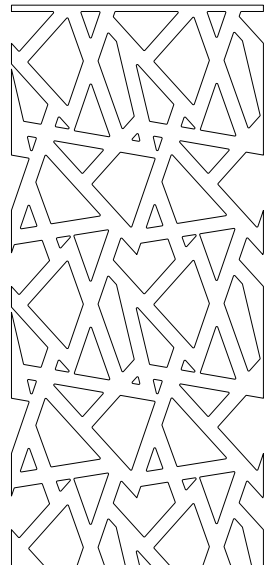

Telugu

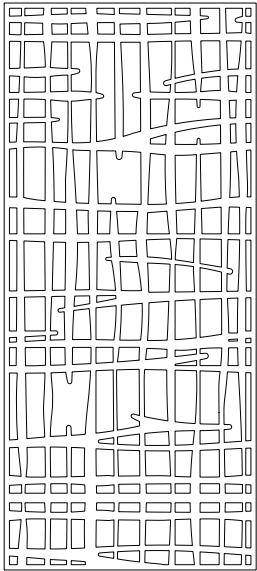

Padmesh

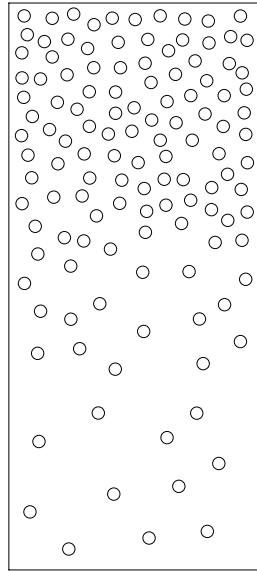

Perdita

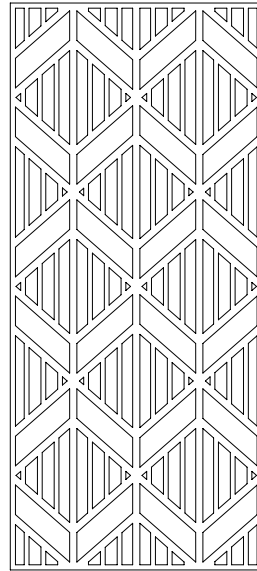

Pivot

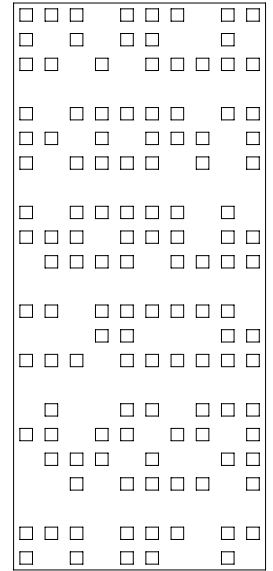

Pixel

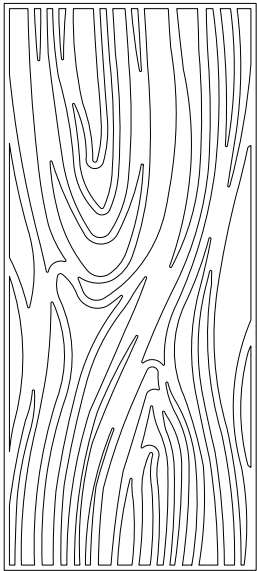

Sankaran

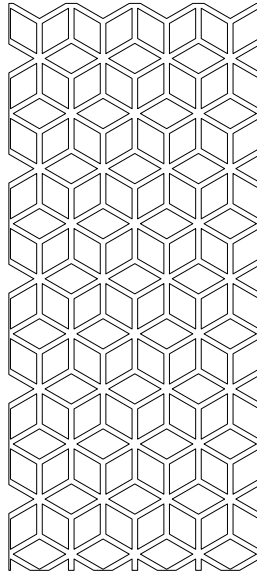

Sanskrit

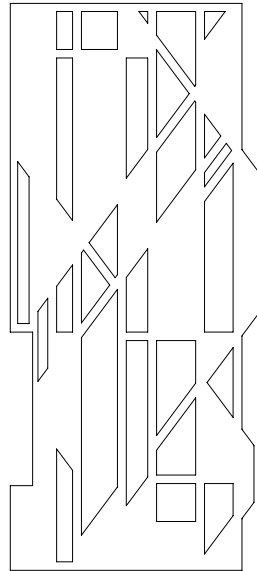

Setro

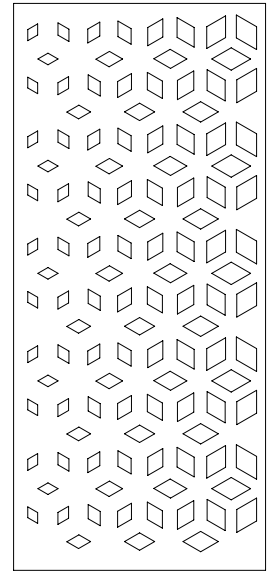

Shard

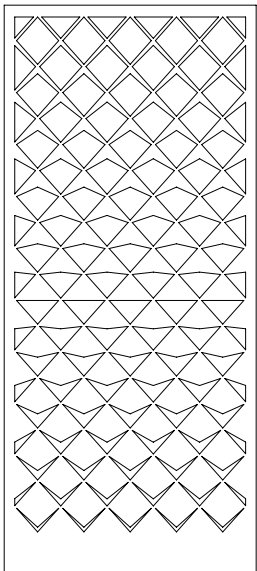

Vanishing

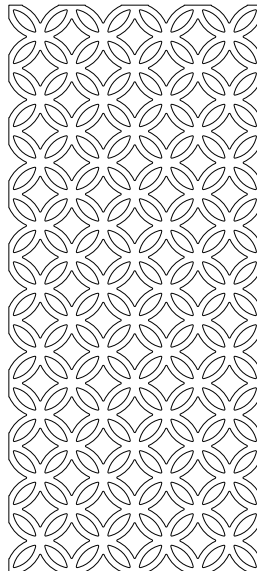

Vedic

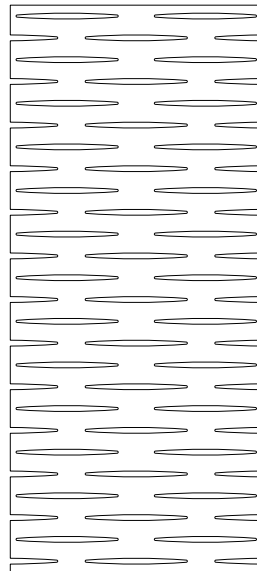

Wamika



44. Zintra Pattern Wamika in Malachite, shown with Zintra Sliding Screen hardware

# Zintra Sliding Screen



Zintra Pattern Devraj in Linen, shown with Zintra Sliding Screen hardware

Zintra Sliding Screens combines Zintra Patterns with easy to install hardware, allowing flexible room division with outstanding acoustic quality.



Zintra Pattern Bhushan in Sky, shown with Zintra Sliding Screen hardware

## SLIDING SCREENS SPECIFICATIONS

Dimensions: North America / Asia – 1.4" (35mm) x 2.2" (56mm) x 96" (2438mm)  
Europe - 1.6" (40mm) x 1.4" (35mm) X 110" (2800mm)

Finishes: Double Sliding Track – Satin Aluminum  
Roller Cover Plates – Stainless Silver

Notes: Roller Kit and Double Sliding Track sold separately

For complete specification and installation information, visit [zintraacoustic.com](http://zintraacoustic.com)

## SLIDING TRACK ASSEMBLY

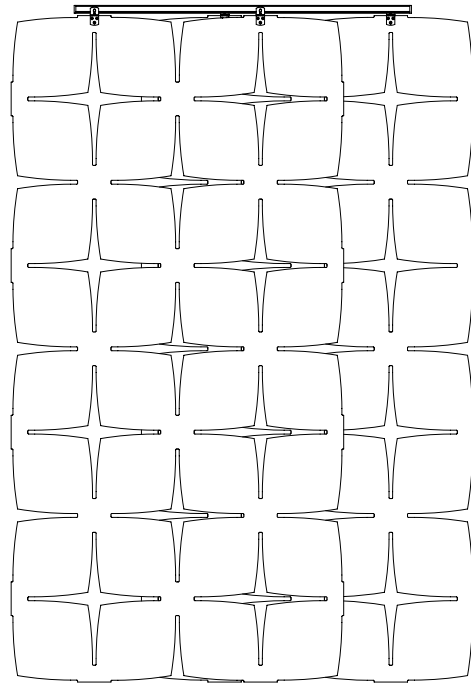

Zintra Patterns not included

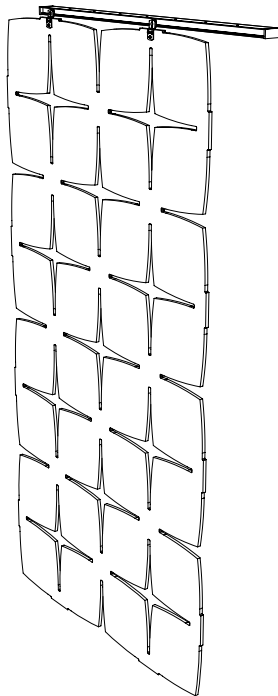

One screen

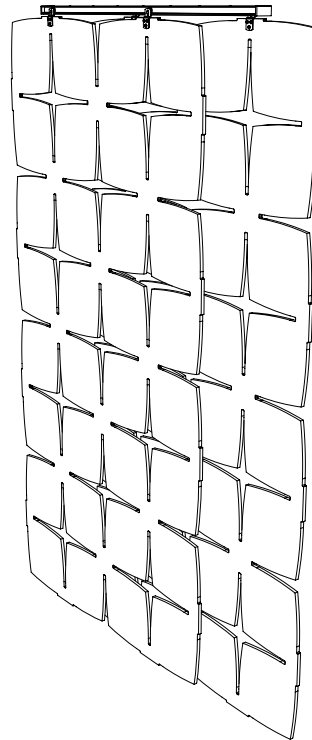

Two screens



48. Zntro Pattern Shard in Cobalt, shown with Floor to Ceiling Cable Kit and Cable Side Grippers



# Zintra Floor to Ceiling



Zintra Pattern Punto in Slate, shown with Floor to Ceiling Cable Kit and Cable Standoffs

Utilizing a steel cable to suspend Zintra 1/2" (12mm) Sheets or Patterns, Floor to Ceiling is an easy-to-install and cost-effective room dividing solution.



Zintra Pattern Astra in Sunshine, on Floor to Ceiling Cables with Cable Side Grippers

## FLOOR TO CEILING SPECIFICATIONS

Dimensions: Floor to Ceiling Cables 13' (4000mm) long

Finishes: Floor to Ceiling Cable Kit – Silver

Cable Side Gripper – Brushed Stainless Steel

Cable Standoff – Brushed Stainless Steel

Notes: Floor to Ceiling Cable Kit includes; cable, floor mount, and ceiling mount

Cable Side Grippers and Cable Standoffs sold separately

For complete specification and installation information, visit [zintraacoustic.com](http://zintraacoustic.com)

Cable Side Gripper

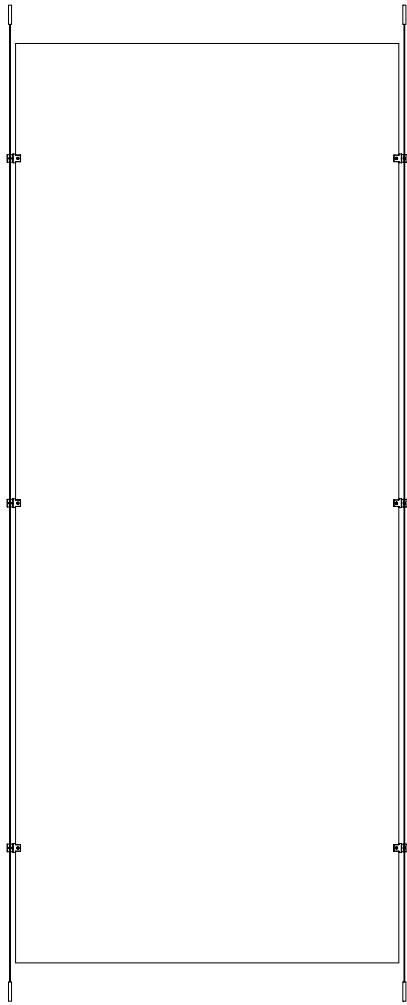

Cable Standoff

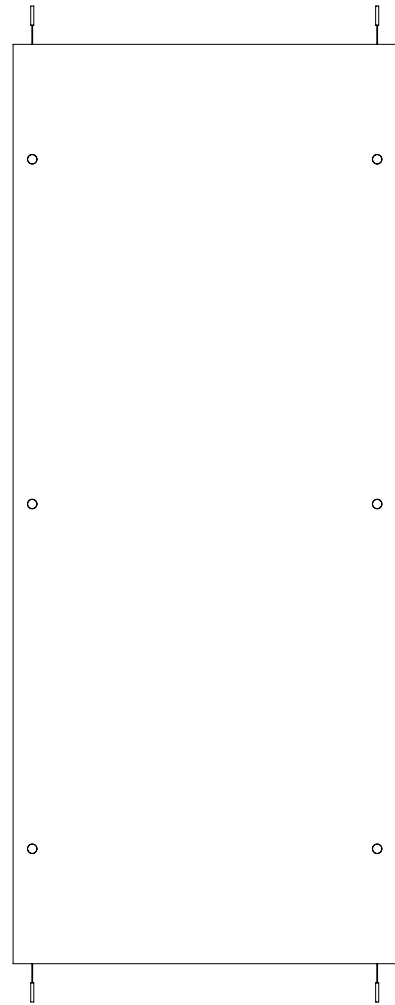

Cable Side Gripper Single



Cable Standoff



# Zintra Patterns Tile



Zintra Pattern Tiles Striae in Brick

Zintra Patterns Tile offers 6 new progressive, seamless easy to install designs in this Zintra favourite. Mix and match the Patterns Tile designs with 24 front and back colors to create 1000s of different combinations – and that's even before you decide how to lay them out on the wall!

# ARCH

Available in boxes of 12

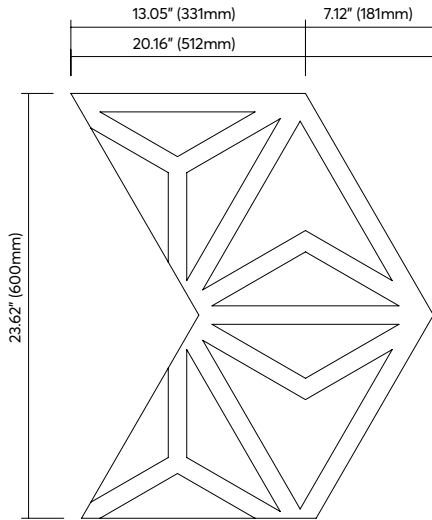

Front View

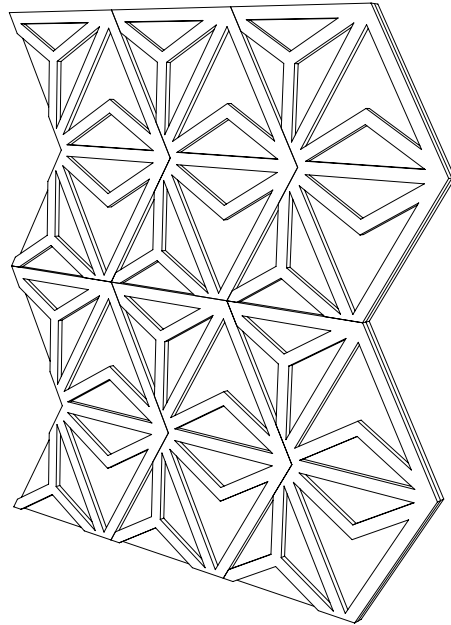

6 Tile Assembly

---

# ENTWINE

Available in boxes of 10

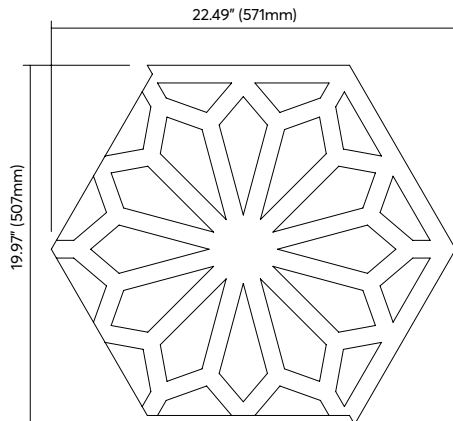

Front View

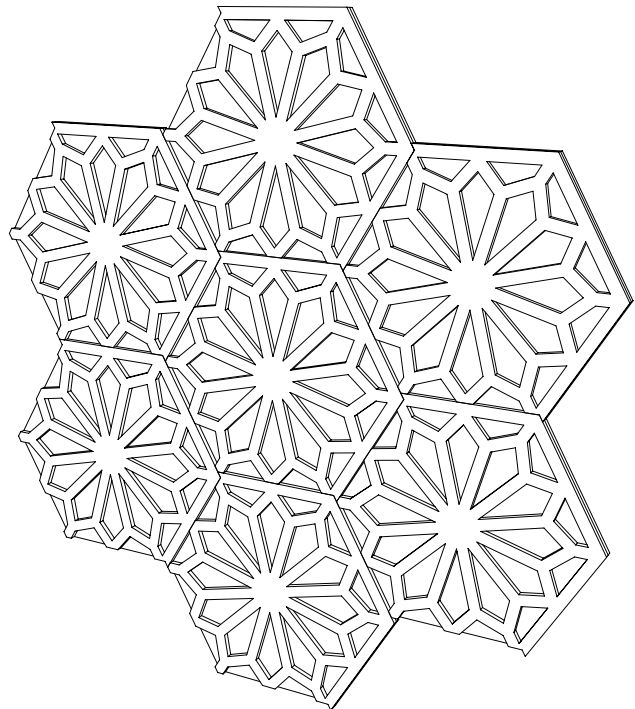

7 Tile Assembly

**LEAP**  
Available in boxes of 10

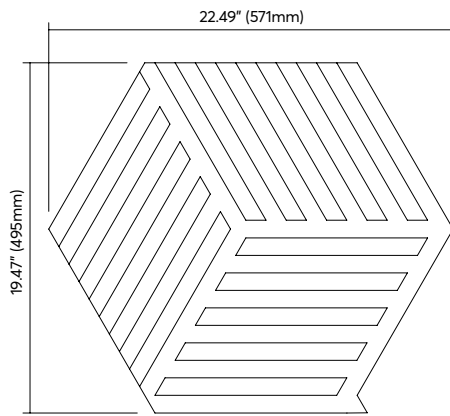

Front View

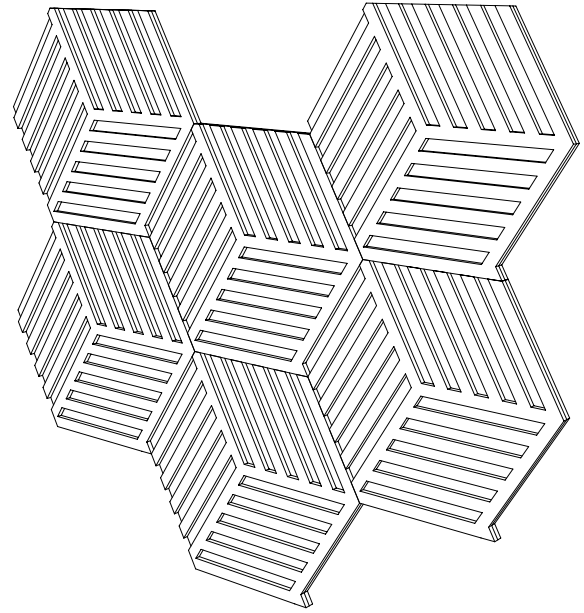

6 Tile Assembly

**LOTUS**  
Available in boxes of 10

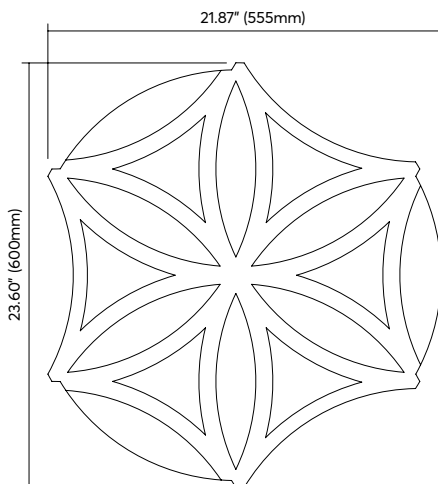

Front View

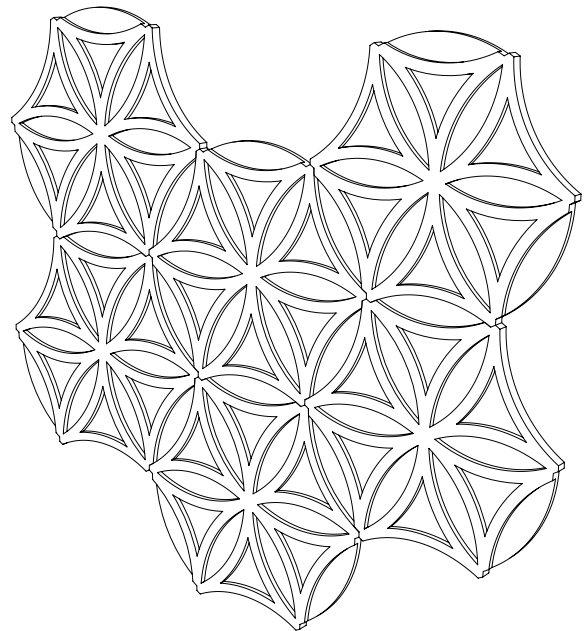

6 Tile Assembly



Zintra Pattern Tiles Leap in Smoke on Cobalt

**PATTERN TILES SPECIFICATIONS**

- Dimensions: See pages 54-57
  - Thickness: 1" (24mm)
  - Colors: Available in all 24 colors (See page 11)
  - NRC Rating: 0.45 (See pages 8-9)
  - Aw Rating: 0.30 (See pages 8-9)
  - Notes: Custom sizes available
- For complete specification and installation information, visit [zintraacoustic.com](http://zintraacoustic.com)

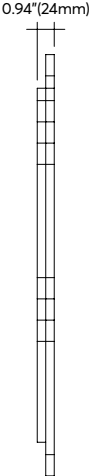

Side View



**STRIAE**  
Available in boxes of 16

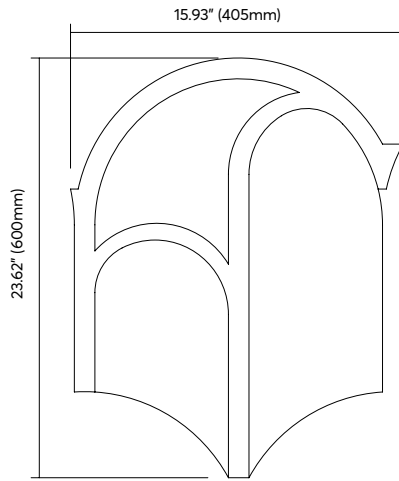

Front View

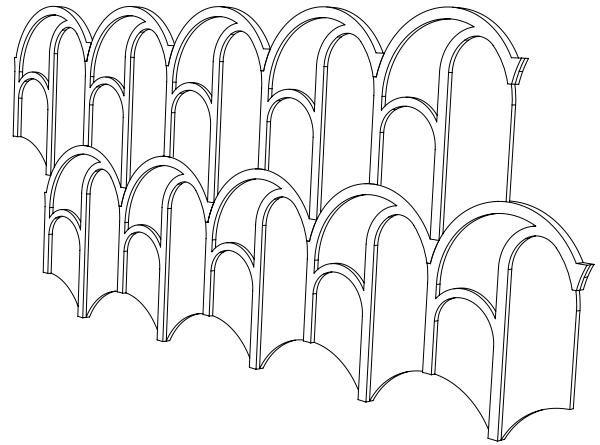

10 Tile Assembly

---

**SURGE**  
Available in boxes of 8

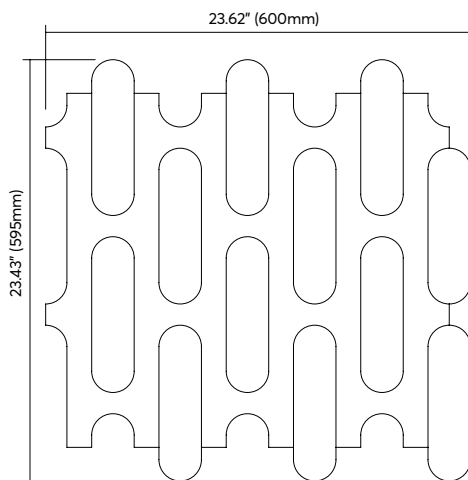

Front View

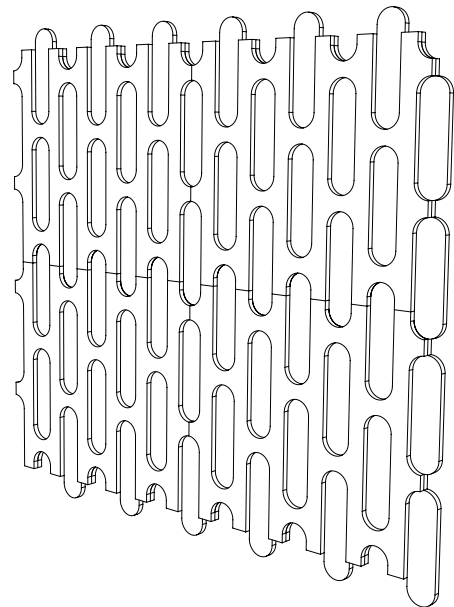

4 Tile Assembly



# Zintra Box Tile



Zintra Box Tiles in Linen, Sunshine, Smoke and Slate

With a range of standard Box Tile sizes and depths, you can give your walls dimension and color while adding the acoustic benefits of Zintra. Easy to layout, mix and match and install, Box Tiles are a great addition to any wall.



Zintra Box Tiles in Ivory, Smoke, Pewter and Fossil

## BOX TILES SPECIFICATIONS

Dimensions: Small 9.8" (248mm) w x 9.8" (248mm) h. Available in boxes of 20.  
Medium 9.8" (248mm) w x 19.5" (496mm) h. Available in boxes of 10.  
Large 19.5" (496mm) w x 19.5" (496mm) h. Available in boxes of 5.

Depth: Low 0.5" (12mm)  
Mid 1" (24mm)  
High 1.8" (45mm)

Colors: Available in all 24 colors (See page 11) or digital print

NRC Rating: 0.45 – 0.80 (See pages 8-9)

Aw Rating: 0.30 – 0.75 (See pages 8-9)

Notes: Custom sizes available

For complete specification and installation information, visit [zintraacoustic.com](http://zintraacoustic.com)

## Suggested configurations

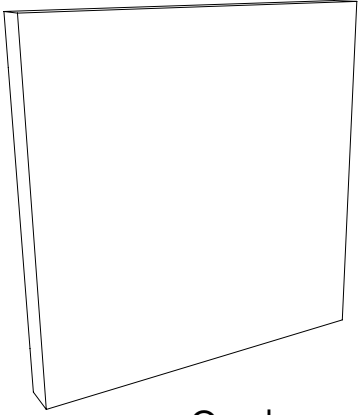

One large

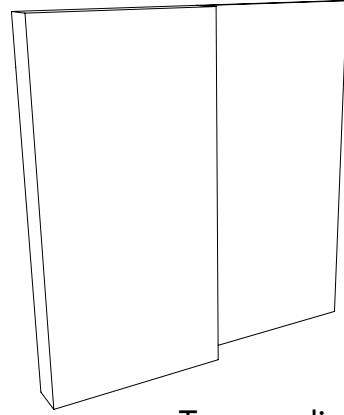

Two medium

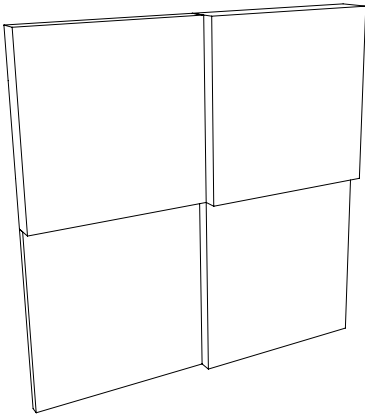

Four small

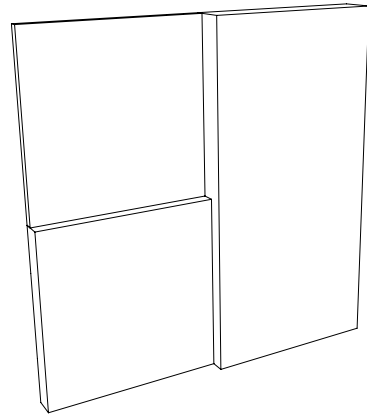

Two small + one medium

Small

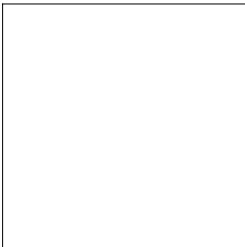

9.8" x 9.8" (248mm x 248mm)

Medium

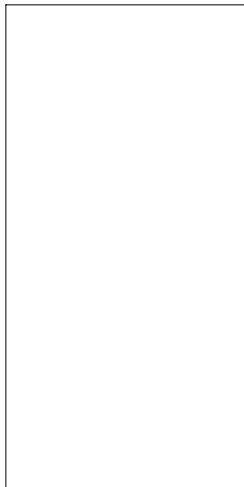

9.75" x 19.5" (248mm x 496mm)

Large

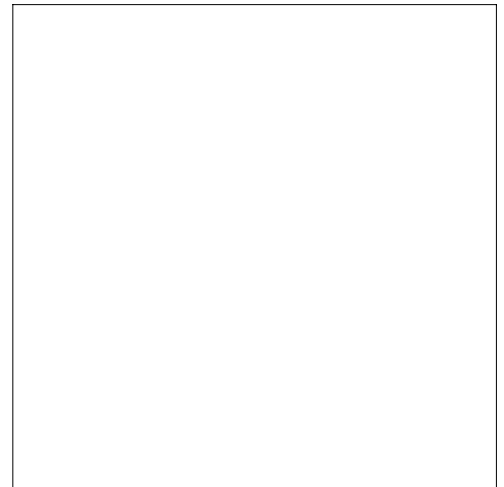

19.5" x 19.5" (496mm x 496mm)



# Zintra Textures



Zintra Texture Cercles in Sky

Zintra Acoustic Textures three-dimensional reliefs create dimension and acoustic refraction on walls. Each carefully cut shape projects from the surface of the panel. Ideal for noisy spaces where good acoustic quality and aesthetics are required.



Zintra Texture Echelle in Pewter

## TEXTURES SPECIFICATIONS

Dimensions: 48" (1220mm) w x 108" (2745mm) h x 1/2" (12mm) d

Colors: Available in all 24 colors (See page 11)

NRC Rating: 0.45 (See pages 8-9)

Aw Rating: 0.30 (See pages 8-9)

Notes: Custom sizes available

For complete specification and installation information, visit [zintraacoustic.com](http://zintraacoustic.com)



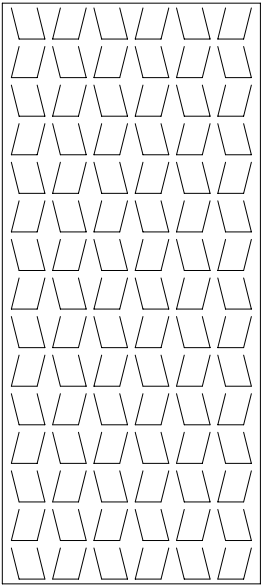

Carre

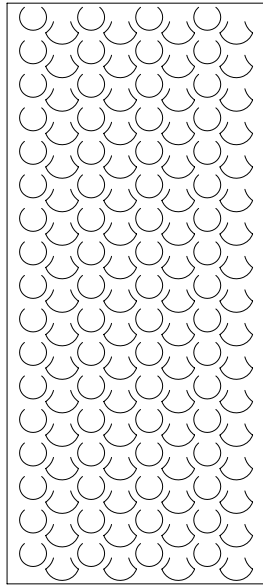

Cercles

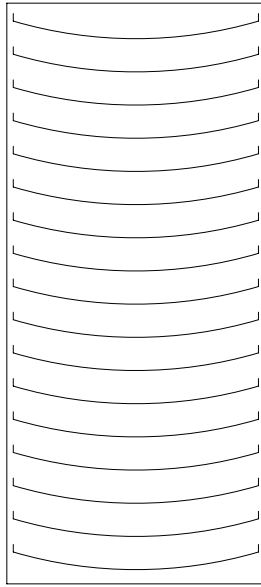

Corbe

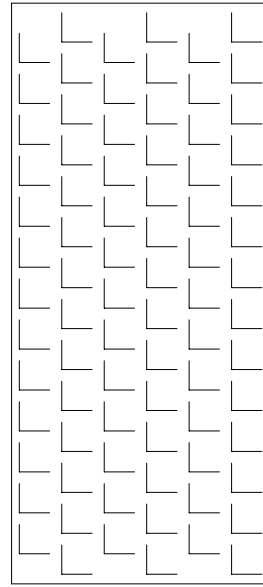

Diamont

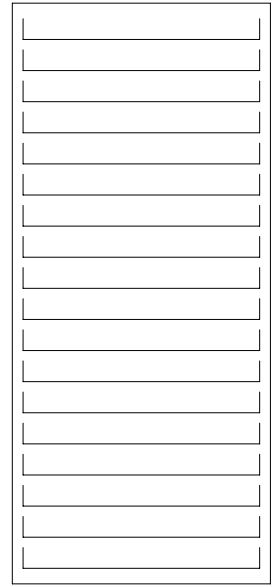

Droit

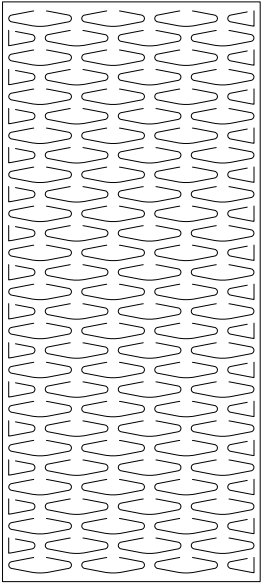

Echelle

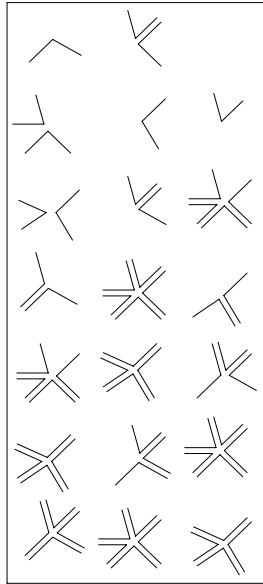

Etoile

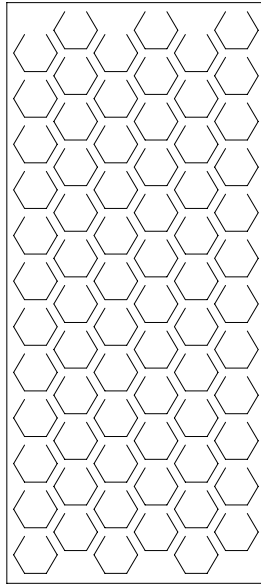

Hexagone

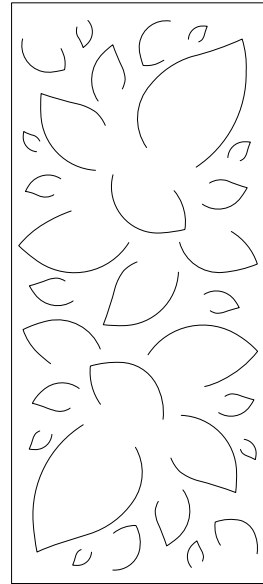

Nenuphar

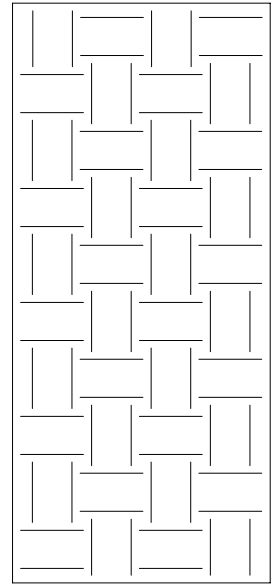

Tissage

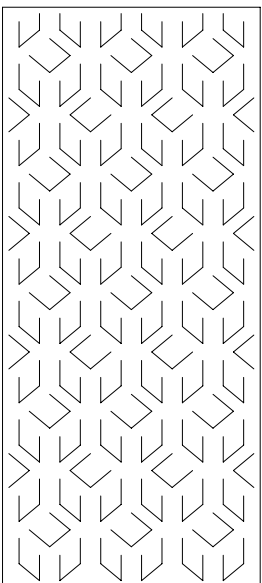

Tessan

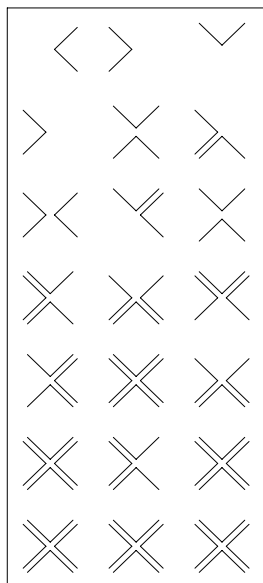

Signe

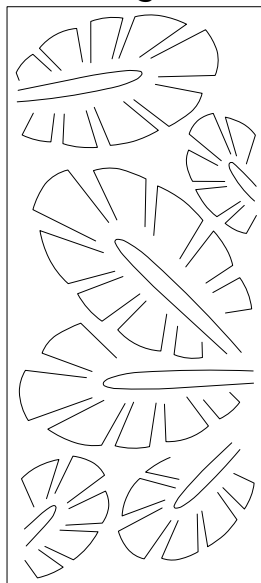

Paume

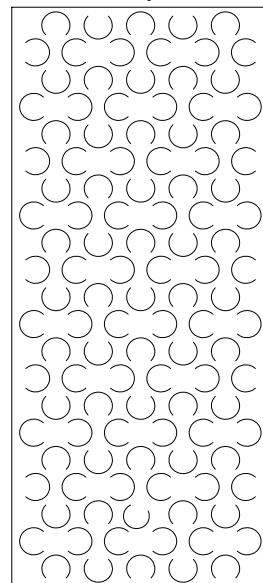

Trappe

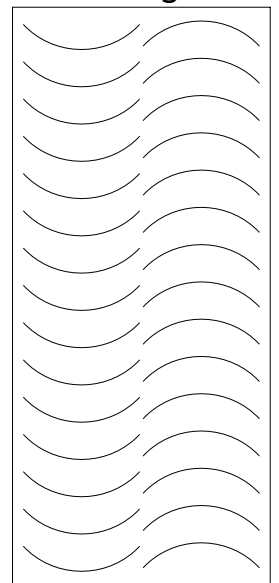

Vague



# Zintra Layers



Zintra Layers in Frost, Greige and Fossil

Carefully layered strips of Zintra create a vivid striped pattern on these panels. Choose Zintra 3D layers in multiple strip heights for added texture and depth. Select multiple colors for a dramatic effect or one color for a more subdued variation.



Zintra Layers 3D in Pewter

## LAYERS SPECIFICATIONS

Dimensions:    Layers            48" (1220mm) w x 108" (2745mm) h x 1" (25mm) d  
                     Layers 3D        48" (1220mm) w x 108" (2745mm) h x 2" (50mm) d

Colors:            Available in all 24 Zintra 1/2" (12mm) Sheet colours (See page 11)

NRC Rating:     0.75 (See pages 8-9)

Aw Rating:       0.60 (See pages 8-9)

Notes:            Custom sizes available

For complete specification and installation information, visit [zintraacoustic.com](http://zintraacoustic.com)

Layers 3D

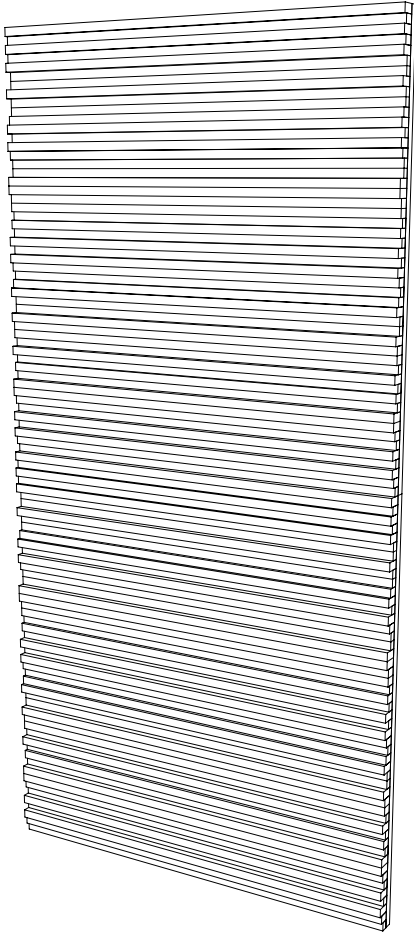

Layers

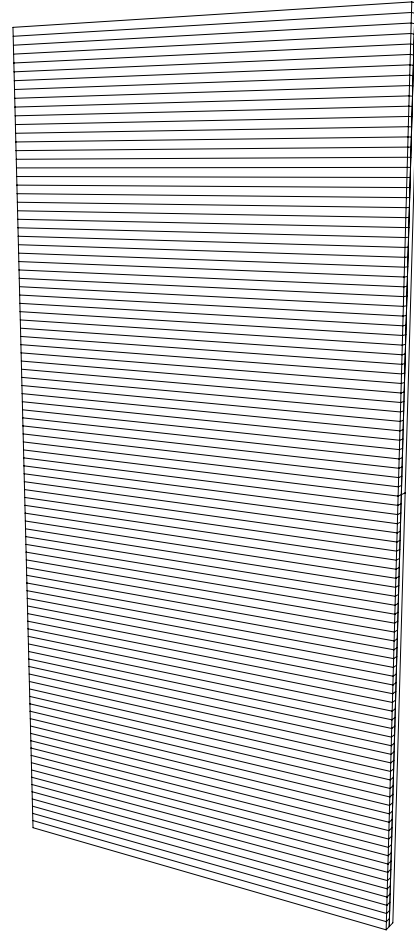

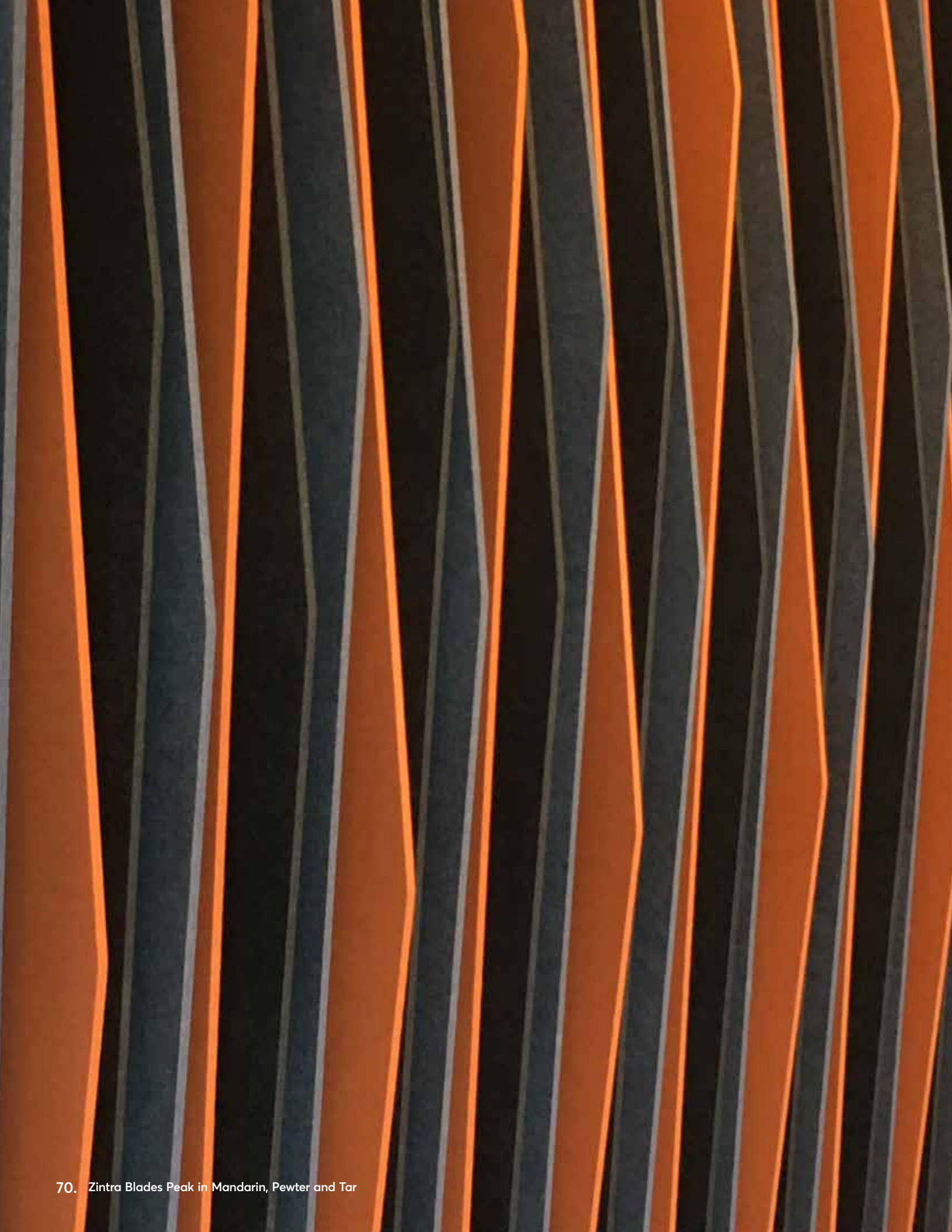

# Zintra Blades



Zintra Blades Swell in Smoke

These wall mounted systems showcase Zintra's flexible characteristics. Combining a dynamic aesthetic appeal and acoustic performance, Blades are an easy-to-install solution. The increased surface area of the vertical blades results in greater absorption of sound compared to flat panels.



Zintra Blades Peak in Ochre

## BLADES SPECIFICATIONS

- Dimensions: 48" (1220mm) w x 54" (1370mm) h  
48" (1220mm) w x 108" (2745mm) h  
Depth varies per design from 4.4" (112mm) – 8.3" (210mm)
- Colors: Available in all 24 colors (See page 11)
- NRC Rating: 0.90 (See pages 8-9)
- Aw Rating: 0.95 (See pages 8-9)
- Finishes: Square Tube 1" x 1" (25mm x 25mm) Satin Aluminium or Black
- Notes: Multi-color available
- For complete specification and installation information, visit [zintraacoustic.com](http://zintraacoustic.com)



# STANDARD BLADE CONFIGURATIONS

## Small Blades

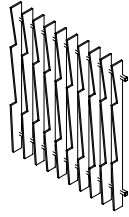
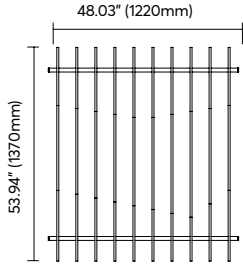

**Bolt**

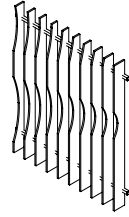

**Canyon**

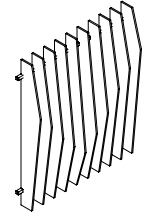

**Peak**

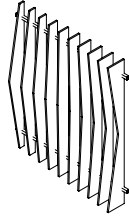

**Ridge**

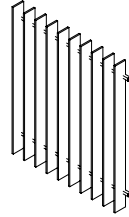

**Square**

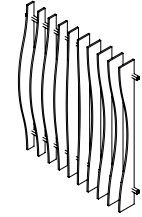

**Swell**

## Large Blades

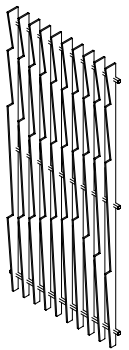
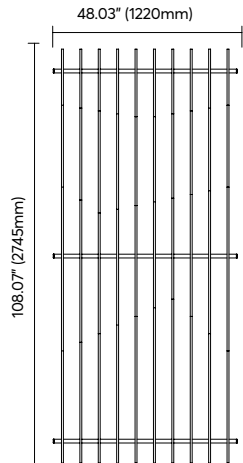

**Bolt**

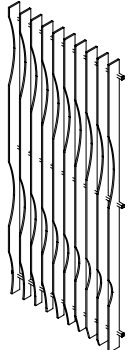

**Canyon**

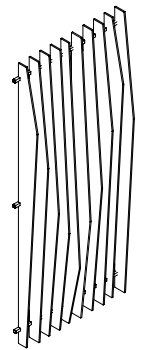

**Peak**

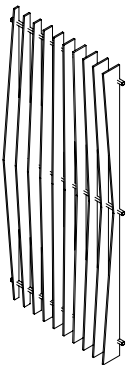

**Ridge**

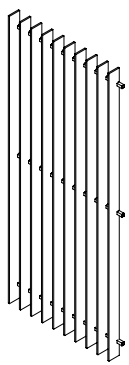

**Square**

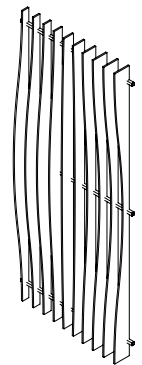

**Swell**



The image shows a restaurant interior with a rustic, industrial aesthetic. The ceiling is the focal point, featuring a series of horizontal wooden beams that create a stepped, staircase-like effect. The walls are also clad in vertical wooden planks. The lighting is warm and varied, including pendant lamps with Edison-style bulbs, recessed ceiling lights, and track lighting. The seating consists of square wooden tables with grey upholstered chairs. A tufted grey booth runs along the back wall. In the foreground, a bar area is visible with a lantern-style light fixture and various bottles. The overall atmosphere is cozy and modern.

# Ceilings

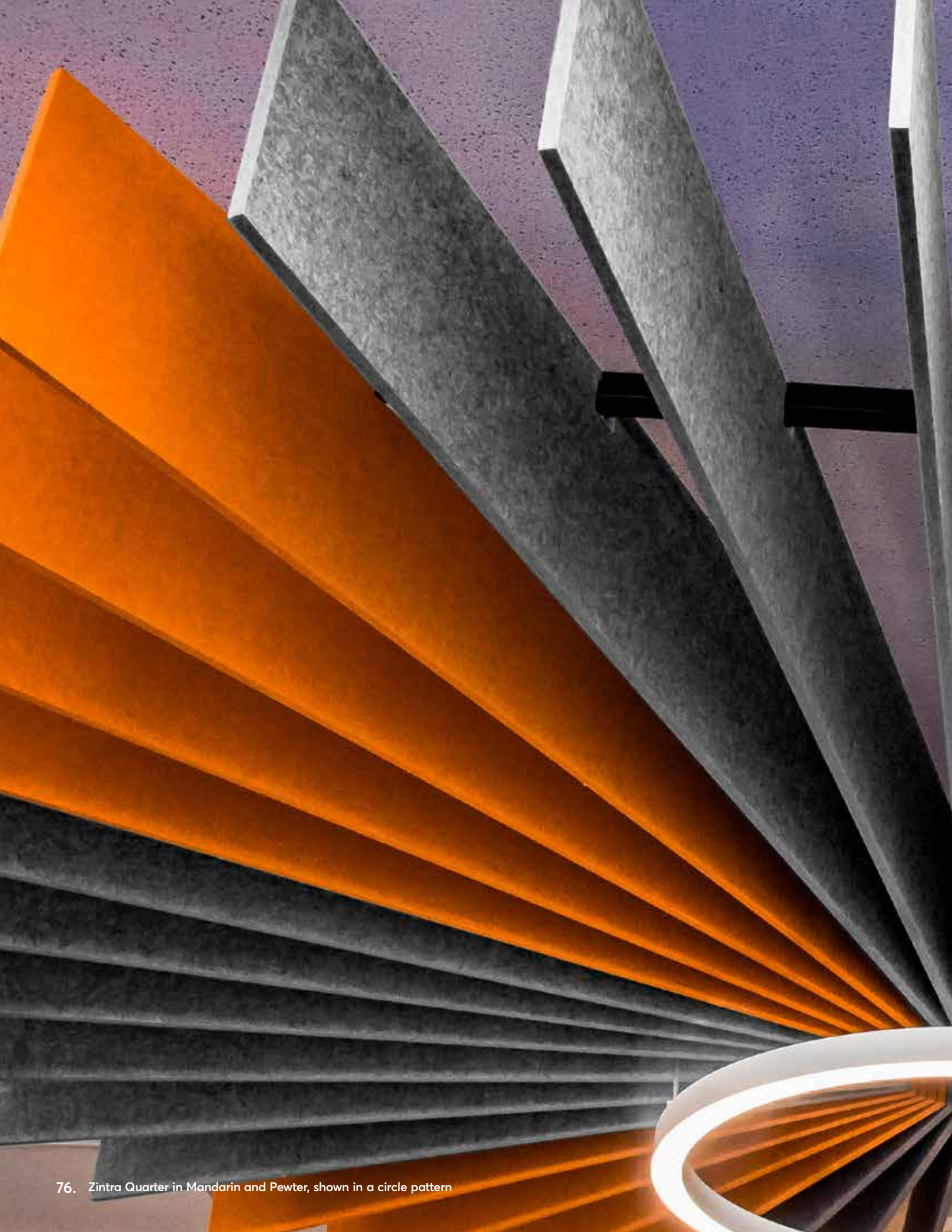

76. Zintra Quarter in Mandarin and Pewter, shown in a circle pattern

# Zintra Quarter Baffles



Zintra Quarter in Linen, shown in a circle pattern

Similar to Zintra's Baffle systems, Zintra Quarter takes the Baffle a step further. Arrayed Baffles create a quarter of a circle. Use four of them to make a full circle or alternate directions for an eye-catching zig zag pattern.



Zintra Quarter in Ecrú and Cobalt. Shown in an alternating pattern

## QUARTERS SPECIFICATIONS

Dimensions: 51.2" (1300mm) w x 72.4" (1839mm) l x 4.3" (110mm) h  
 Adjustable Cable Kit: North America / Asia – 5' (1524mm)  
 Europe – 6 1/2' (2000mm)

Colors: Available in all 24 colors (See page 11)

Finishes: Square Tube 1" x 1" (25mm x 25mm) Satin Aluminium or Black

NRC Rating: 0.90 (See pages 8-9)

Aw Rating: 0.90 (See pages 8-9)

Notes: Only available in Zintra 1/2" (12mm) Sheets  
 Adjustable Cable Kit included  
 Multi-color and digital print available

For complete specification and installation information, visit [zintraacoustic.com](http://zintraacoustic.com)

Quarter Baffle

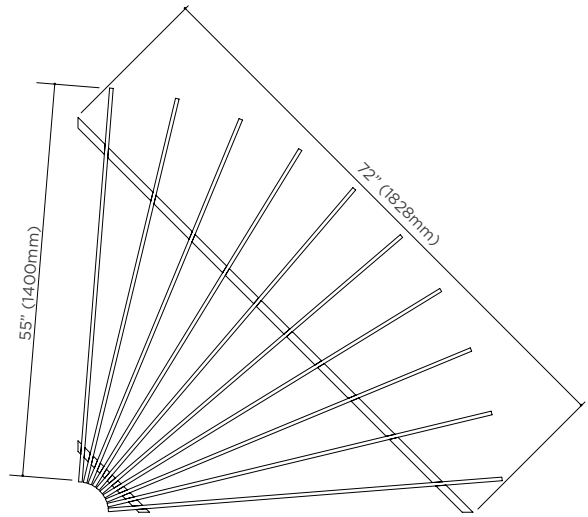
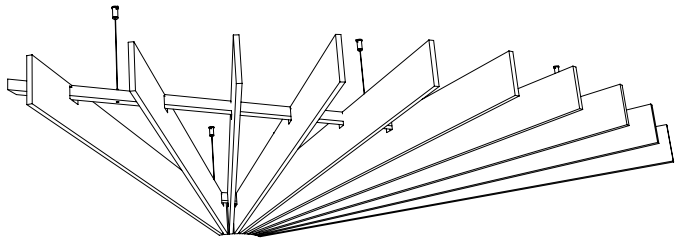

Circle Arrangement

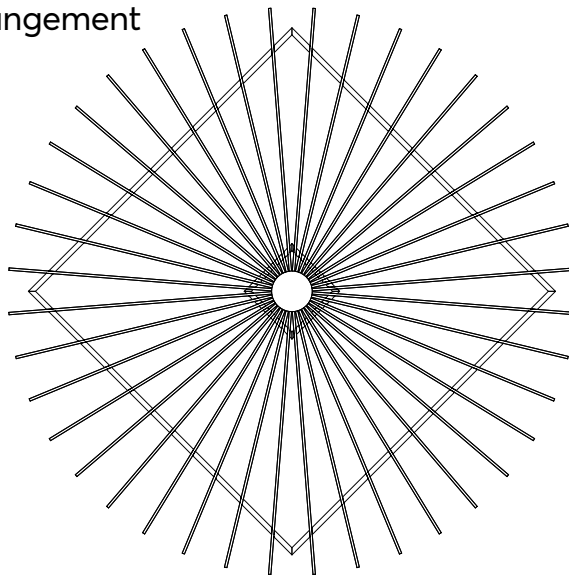

Alternating Arrangement

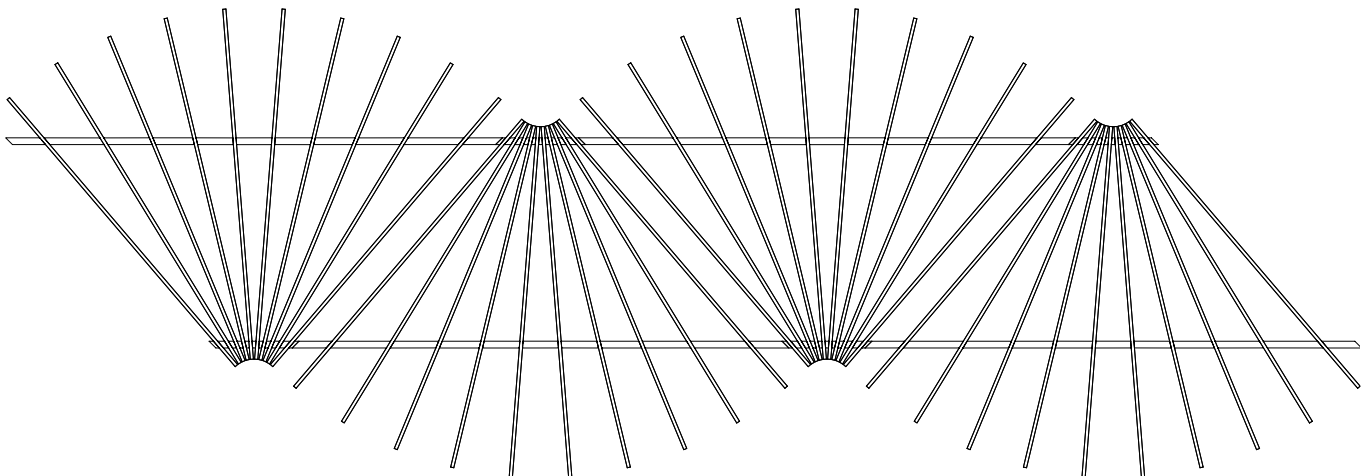



80. Zintra Box Baffles Random in Cadet, Malachite and Fossil



# Zintra Box Baffles



Zintra Box Baffles Uniformed Small in custom digital print graphic

Suspended Box-Shaped Baffles hung in perfectly spaced rows create these high performing Baffles. The box shape feature not only looks more substantial, it also increases the Aw rating by capturing sound within. Select the same shaped Baffles or mix them up for added dimension.



Zintra Box Baffles Random in Pewter, Slate and Ivory

## BOX BAFFLES SPECIFICATIONS

Dimensions: 39.4" (1000mm) w x 47.2" (1200mm) l x 7.87" (200mm) h  
39.4" (1000mm) w x 95.4" (2400mm) l x 7.87" (200mm) h  
\* LOW 2" (50mm) h

Adjustable Cable Kit: North America / Asia – 5' (1524mm)  
Europe – 6 1/2' (2000mm)

Colors: Available in all 24 colors (See page 11)

Finishes: Square Tube 1" x 1" (25mm x 25mm) Black or Satin Aluminium

NRC Rating: 0.90 (See pages 8-9)

Aw Rating: 0.95 (See pages 8-9)

Notes: Adjustable Cable Kit included

Hang from ceiling grid with optional Twist Clip - Threaded  
Multi-color and digital print available

For complete specification and installation information, visit [zintraacoustic.com](http://zintraacoustic.com)

# BOX BAFFLES CONFIGURATIONS

## Random\*

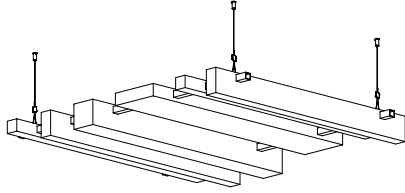

Isometric

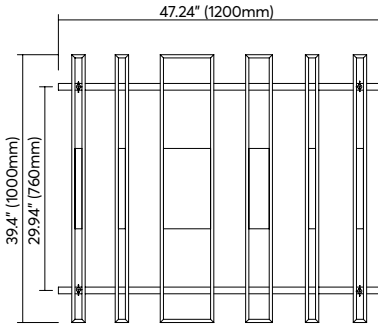

Top

## Mixed\*

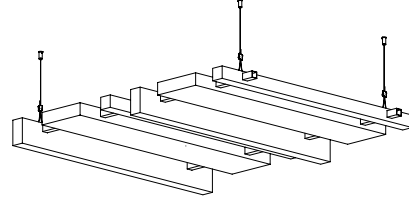

Isometric

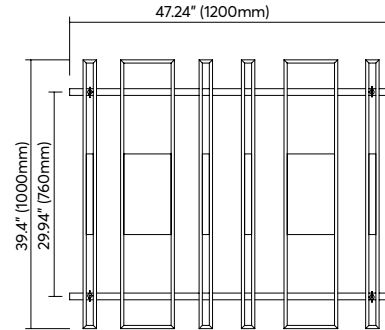

Top

## Uniformed Low\*

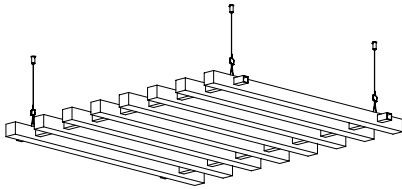

Isometric

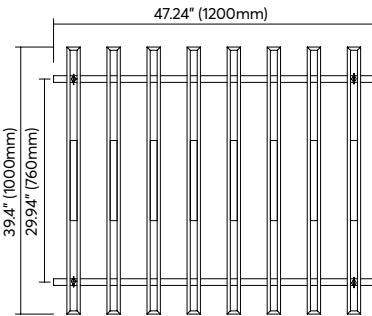

Top

## Uniformed High\*

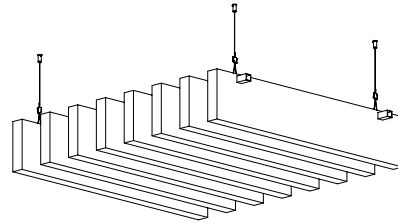

Isometric

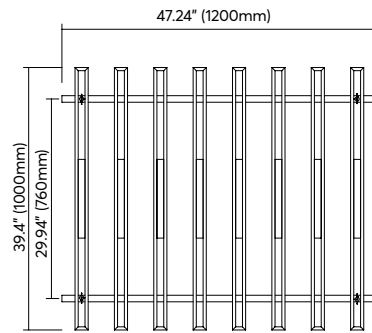

Top

\* Also available in 39.4" (1000mm) w x 95.4" (2400mm) l

### Box Baffle A

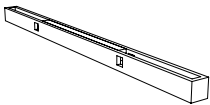

2" (50mm) w x 39.4" (1000mm) l x 2" (50mm) h

### Box Baffle B

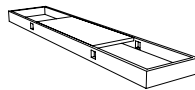

7.9" (200mm) w x 39.4" (1000mm) l x 2" (50mm) h

### Box Baffle C

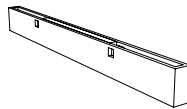

2" (50mm) w x 39.4" (1000mm) l x 3.9" (100mm) h

### Box Baffle D

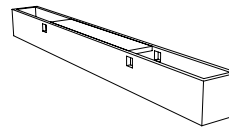

3.9" (100mm) w x 39.4" (1000mm) l x 3.9" (100mm) h

### Box Baffle E

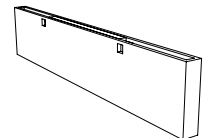

2" (50mm) w x 39.4" (1000mm) l x 7.9" (200mm) h



# Zintra Baffle Systems



Zintra Ridges Baffle Systems in Cobalt

Zintra Baffle Systems are an innovative replacement to a mineral fiber ceiling system. Easy to assemble and install, they are available in a large array of designs. Baffle Systems are ideally suited to large noisy spaces in educational institutions, shopping centers, offices, restaurants and airports.



Zintra Bolt Baffle System in Fossil

## BAFFLE SYSTEMS SPECIFICATIONS

|             |  |  |
|-------------|--|--|
| Dimensions: | Small Baffle   | 48" (1220mm) w x 48" (1220mm)                                  |
|             | Large Baffle   | 48" (1220mm) w x 108" (2745mm)                                 |
|             | Adjustable Cable Kit:                                      | North America / Asia – 5' (1524mm)<br>Europe – 6 1/2' (2000mm) |
| Depths:     | 4.8" (120mm) or 9.5" (240mm)                               |  |
| Colors:     | Available in all 24 colors (See page 11)                   |  |
| Finishes:   | Square Tube 1" x 1" (25mm x 25mm) Black or Satin Aluminium |  |
| NRC Rating: | 0.90 (See pages 8-9)                                       |  |
| Aw Rating:  | 0.95 (See pages 8-9)                                       |  |
| Notes:      | Adjustable Cable Kit included                              |  |
|             | Hang from ceiling grid with optional Twist Clip - Threaded |  |
|             | Multi-color and digital print available                    |  |

For complete specification and installation information, visit [zintraacoustic.com](http://zintraacoustic.com)

**STANDARD BAFFLE SYSTEM OPTIONS:**

**Small baffle**

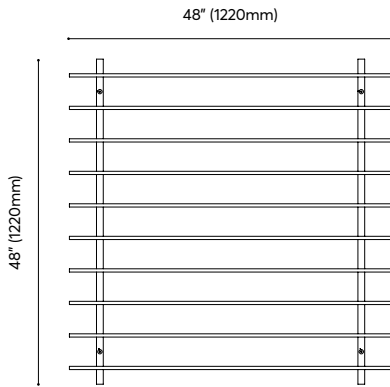

**Large baffle**

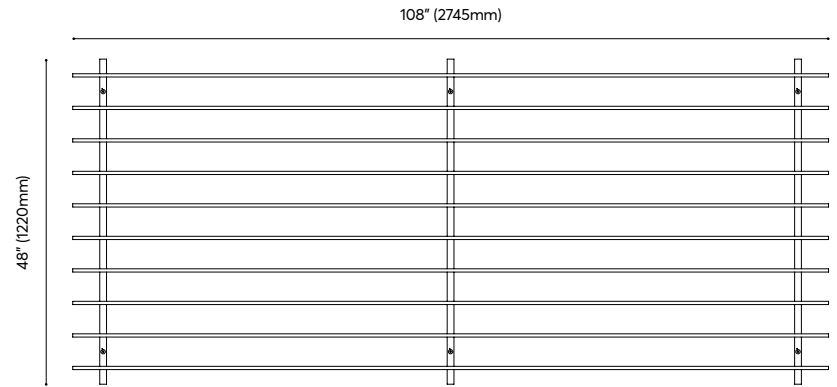

**Square**

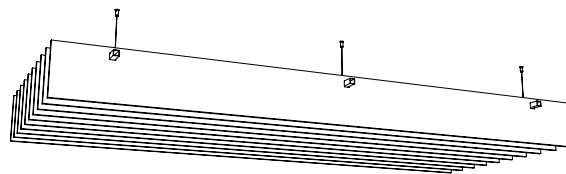
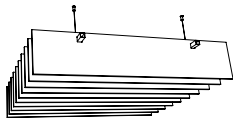

**Bolt**

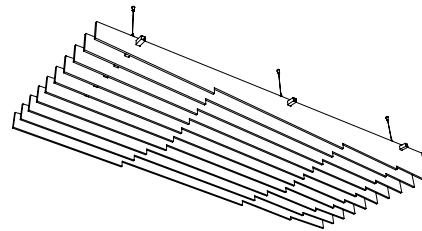
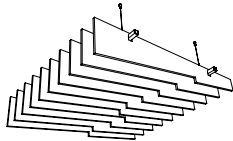

**Canyons**

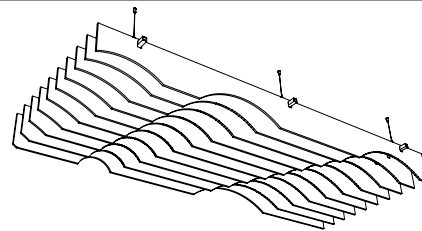
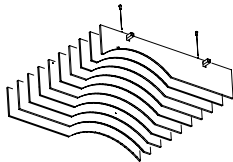

**Ridges**

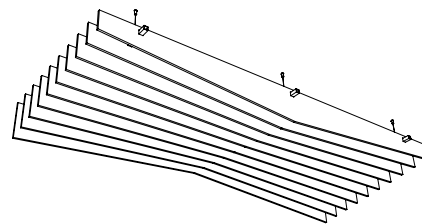
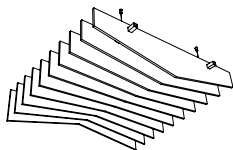

**Swell**

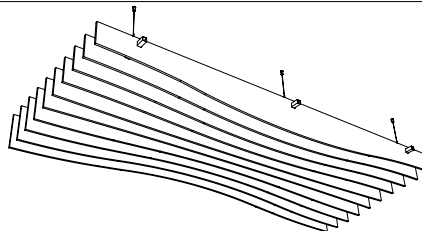
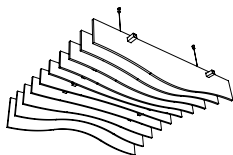

**Gorge\***

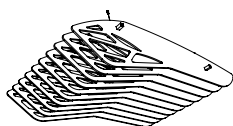

\* also available in 48"(1220mm) w x 72" (1829mm) l x 18" (456mm) h



88. Zintra Individual Baffles in Linen. Shown as Hook Baffles



# Zintra Individual Baffles



Zintra Individual Baffles in Linen and Fossil

Each Baffle hangs from its own set of cables, providing flexibility in the installation and design process. Individual Baffles will control acoustics in any scaled space while achieving an endless array of dynamic layouts.



Zintra Individual Baffles in Pewter. Shown as Hook Baffles

## INDIVIDUAL BAFFLES SPECIFICATIONS

|             |  |
|-------------|--|
| Length:     | Maximum 108" (2745mm)                    |
| Depths:     | 4.7" (120mm) or 9.5" (240mm)             |
| Colors:     | Available in all 24 colors (See page 11) |
| Finishes:   | Adjustable Cable Kit    Silver           |
|             | S-Hook                        Silver     |
|             | Twist Clip – Loop        White           |
|             | Twist Clip – Swivel      Clear           |
| NRC Rating: | 0.90 (See pages 8-9)                     |
| Aw Rating:  | 0.95 (See pages 8-9)                     |
| Notes:      | Custom sizes available                   |

For complete specification and installation information, visit [zintraacoustic.com](http://zintraacoustic.com)

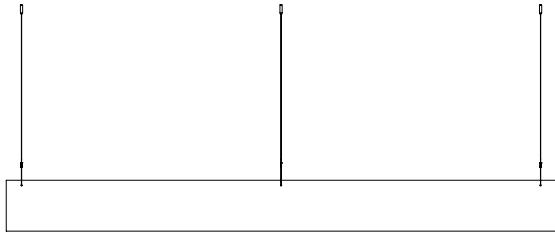

Individual Baffle – Adjustable Cable Kit

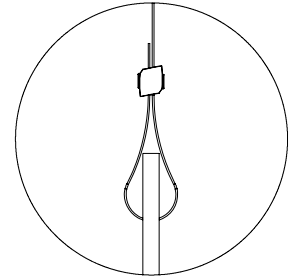
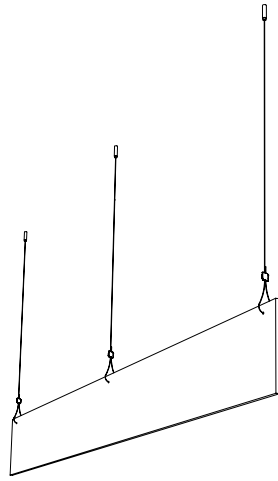

Adjustable  
cable through  
Zintra

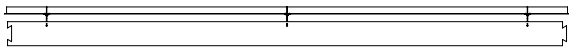

Individual Baffle – Hook  
(does not include ceiling grid)

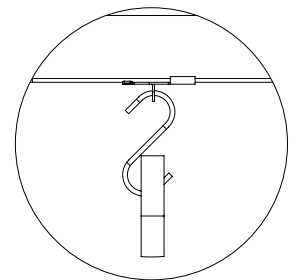
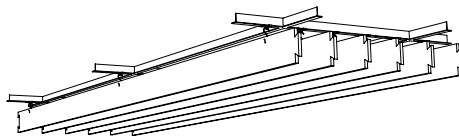

Twist Clip Loop  
on ceiling grid  
with S-hook  
through Zintra



# Zintra Connect



Zintra Connect Cirrus in Frost

Add sculptural form to your ceiling with Zintra Connect.  
Designed with full or partial ceiling coverage in mind.  
Each system easily fits together and connects to  
those adjacent without using any hardware.



Zintra Connect Rise in Chambray

## CONNECT SPECIFICATIONS

Dimensions: Cirrus Low 89.6" (2275mm) w x 141.5" (3595mm) l x 7.5" (190mm) h  
Cirrus High 89.6" (2275mm) w x 141.5" (3595mm) l x 11.8" (300mm) h  
Rise Low 109.8" (2790mm) w x 48" (1220mm) l x 8.7" (220mm) h  
Rise High 109.8" (2790mm) w x 48" (1220mm) l x 10.2" (260mm) h  
Adjustable Cable Kit: North America / Asia – 5' (1524mm)  
Europe – 6 1/2' (2000mm)

Colors: Available in all 24 colors (See page 11)

Finishes: Adjustable Cable Kit – Silver

NRC Rating: 0.90 (See pages 8-9)

Aw Rating: 0.95 (See pages 8-9)

Notes: Only available in Zintra 1/2" (12mm) Sheets

Hang from ceiling grid with optional Twist Clip - Threaded

Adjustable Cable Kit included

Multi-color available

For complete specification and installation information, visit [zintraacoustic.com](http://zintraacoustic.com)

Cirrus

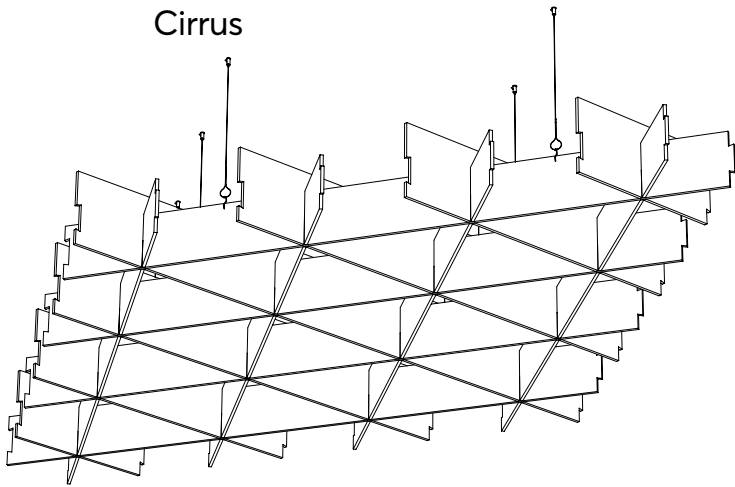

Typical perspective from underneath

Rise

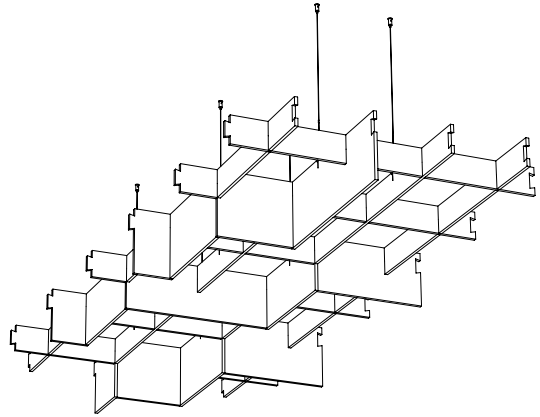

Typical perspective from underneath

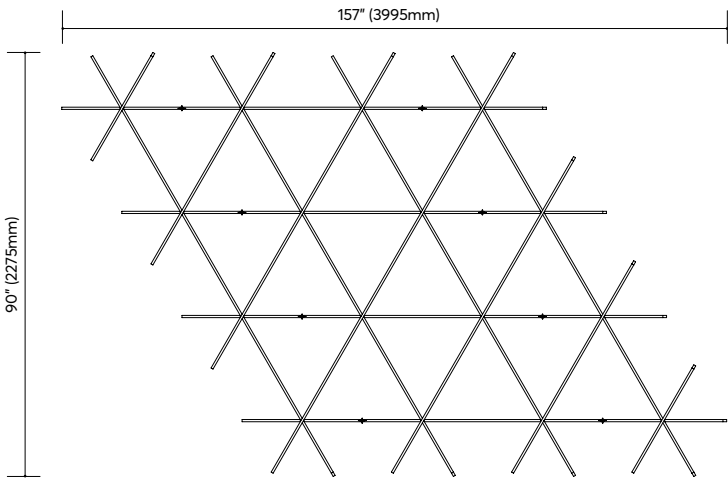

Plan view

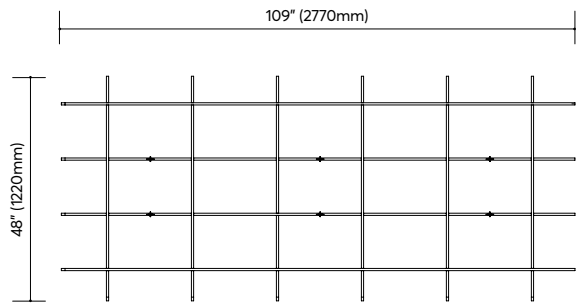

Plan view

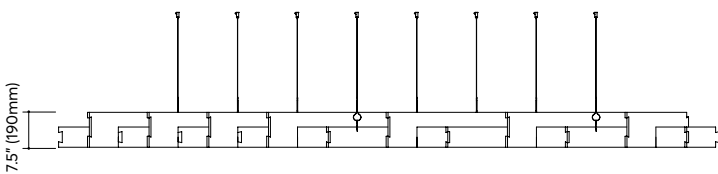

Cirrus Low

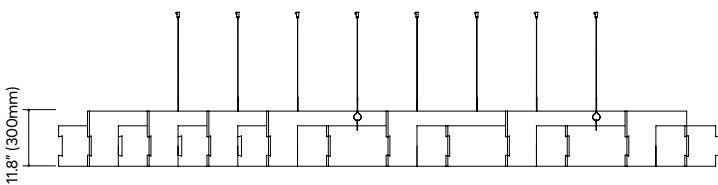

Cirrus High

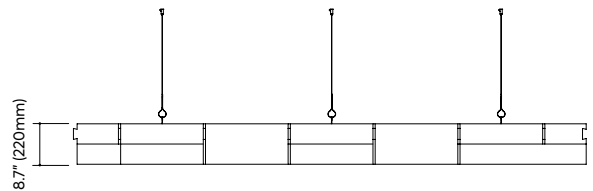

Rise Low

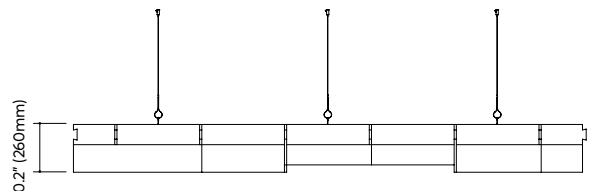

Rise High





# Zintra Clouds



Zintra Clouds Giffard in Pewter, Grass and Ecrú

Attention grabbing three-dimensional designs in a variety of sizes and colors are a guaranteed way to add interest while keeping noise levels down. Each Cloud easily pressure fits together and quickly hangs.



Zintra Stratus Clouds in Smoke

## CLOUDS SPECIFICATIONS

Dimensions: (See page 99)

Colors: Available in all 24 colors (See page 11)

Finishes: Adjustable Cable Kit – Silver

NRC Rating: 0.90 (See pages 8-9)

Aw Rating: 0.95 (See pages 8-9)

Notes: Adjustable Cable Kits included

Hang from ceiling grid with optional Twist Clip - Threaded

Multi-color available

For complete specification and installation information, visit [zintraacoustic.com](http://zintraacoustic.com)

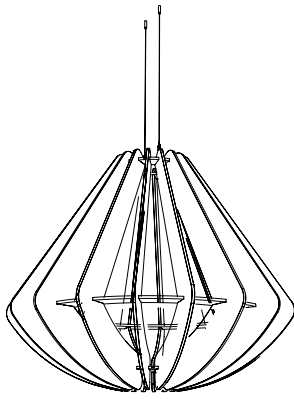

**Blanchard**

27.3" (694mm) dia x 23.5" (595mm) h  
56.4" (1432mm) dia x 47" (1195mm) h

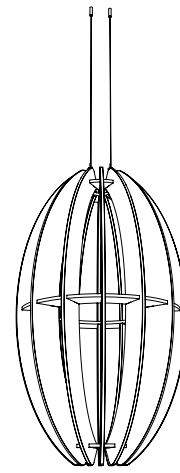

**Giffard**

14.4" (364mm) dia x 23.5" (595mm) h  
27.3" (692mm) dia x 47" (1195mm) h  
45.6" (1160mm) dia x 71" (1802mm) h

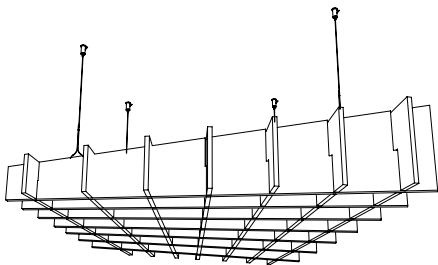

**Clochette**

39" (992mm) w x 44.1" (1121mm) l x 9.2" (232mm) h

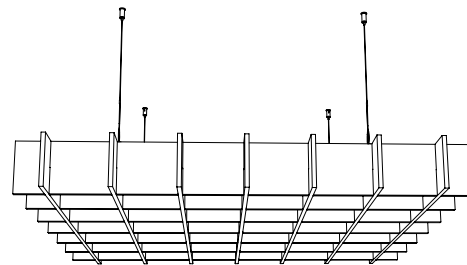

**Square**

48" (1220mm) w x 48" (1220mm) l x 5.9" (150mm) h  
48" (1220mm) w x 108" (2745mm) l x 5.9" (150mm) h  
108" (2745mm) w x 108" (2745mm) l x 5.9" (150mm) h  
108" (2745mm) w x 108" (2745mm) l x 8.9" (225mm) h

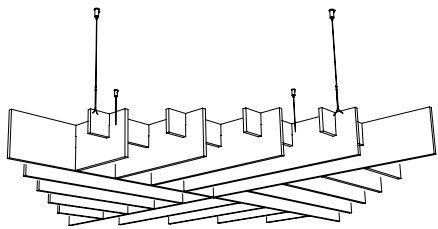

**Drante**

48" (1220mm) w x 48" (1220mm) l x 5.5" (140mm) h  
72.1" (1832mm) w x 72.1" (1832mm) l x 9" (229mm) h

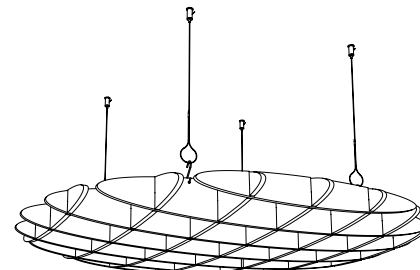

**Yoofoe**

48" (1220mm) dia x 6.2" (156mm) h  
72" (1829mm) dia x 8" (204mm) h  
96" (2438mm) dia x 10" (254mm) h  
108" dia" (2745mm dia) x 10.1" (257mm) h

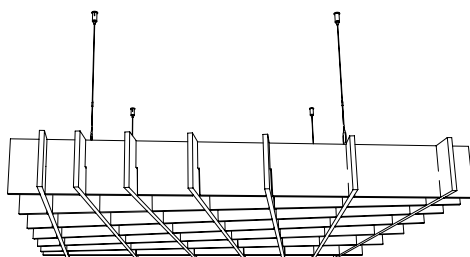

**Warp**

48" (1220mm) w x 48" (1220mm) l x 5.5" (140mm) h

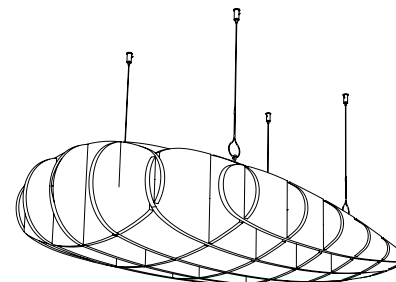

**Stratus**

28" (711mm) w x 55" (1398mm) l x 11.5" (290mm) h



# Zintra Shapes



Zintra Shapes Square and Triangle in Slate and Ecru

Using common geometric forms, add character with Zintra Acoustic Shapes. Install them in a focused area to draw attention or spread them throughout to create a progressive design.

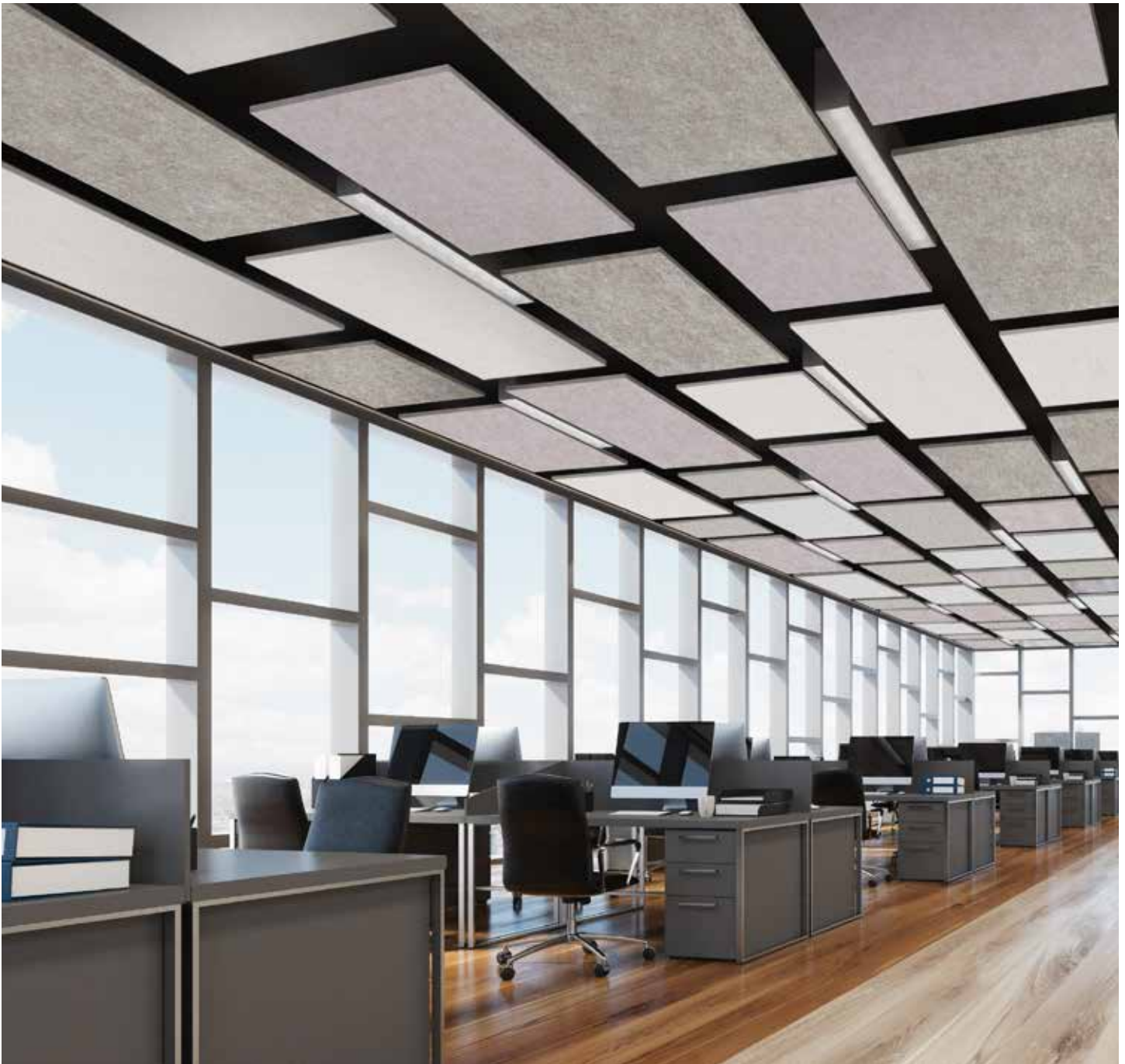

Zintra Shapes Large Rectangle and Square in Linen, Ivory, and Ecrú

## SHAPES SPECIFICATIONS

- Dimensions: (See page 103)
- Colors: Available in all 24 colors (See page 11)
- Finishes Adjustable Cable Kit – Silver
- NRC Rating: 0.90 (See pages 8-9)
- Aw Rating: 0.95 (See pages 8-9)
- Notes: Only available in Zintra 1/2" (12mm) Sheets  
Hang from ceiling grid with optional Twist Clip - Threaded  
Adjustable Cable Kits included  
Multi-color Sheets and Digital Print available

For complete specification and installation information, visit [zintraacoustic.com](http://zintraacoustic.com)

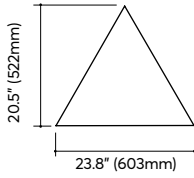

Small Triangle

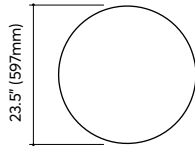

Small Circle

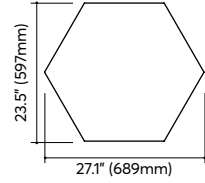

Small Hexagon

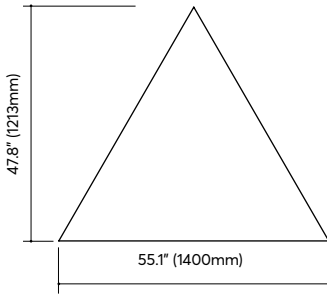

Large Triangle

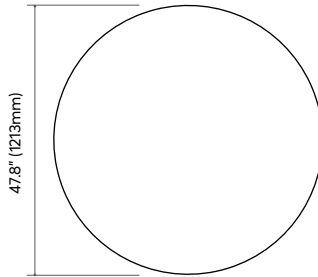

Large Circle

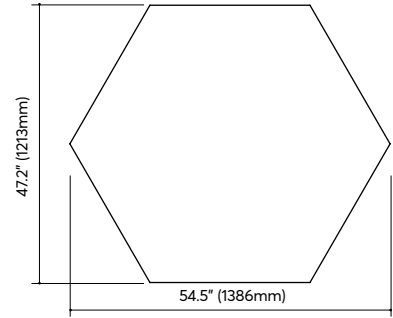

Large Hexagon

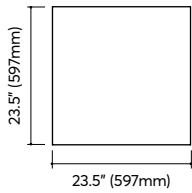

Small Square

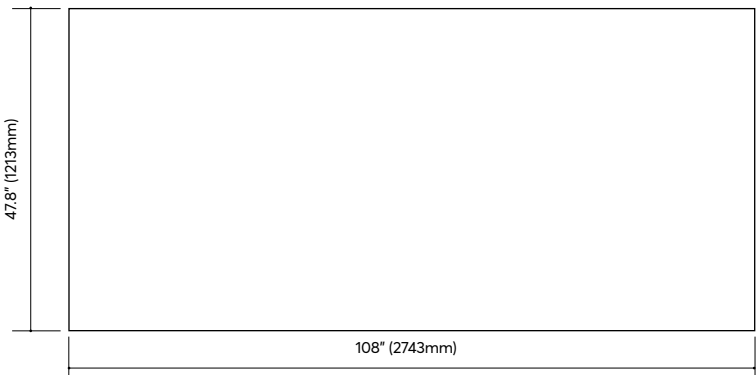

Large Rectangle

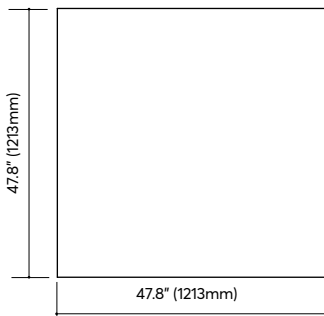

Large Square







# Accessories



# Zintra Concertina



Zintra Concertina Bhushan in Frost on Ivory, shown with Zintra Concertina stand

Creating a well-balanced environment has never been easier than with Zintra Concertina. No assembly is required. Just unfold, stand up and adjust the panels to the angle that suits. When no longer needed, simply fold concertina flat and store away.



Zintra Hex Concertina in Chambray on Ivory

## CONCERTINA SPECIFICATIONS

Dimensions: 71.2" (1810mm) w x 72" (1830mm) h x 1" (24mm) d  
Folded – 32" (610mm) w x 72" (1830mm) h x 3" (72mm) d

Colors: Available in all 24 colors (See page 11)

NRC Rating: 0.90 (See pages 8-9)

Aw Rating: 0.95 (See pages 8-9)

Notes: Pattern may be specified to one side or both  
Optional Zintra Concertina stand available

For complete specification and installation information, visit [zintraacoustic.com](http://zintraacoustic.com)

Top view



Side view



90 Degrees



Top view

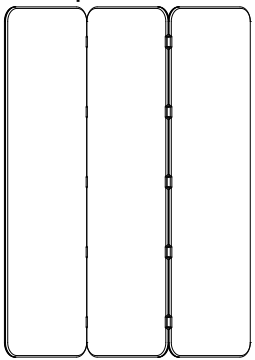

Front view

Side view



Perspective

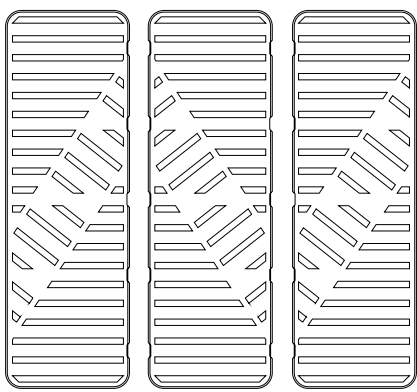
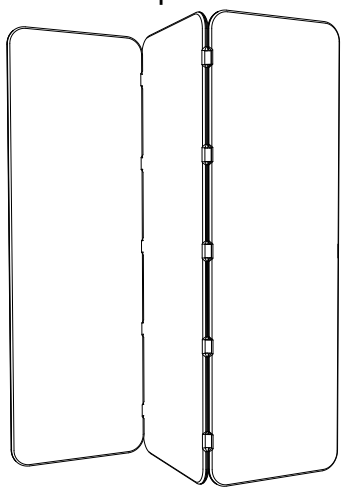

Bhushan

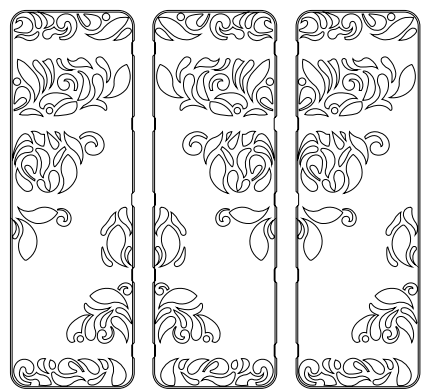

Kerala

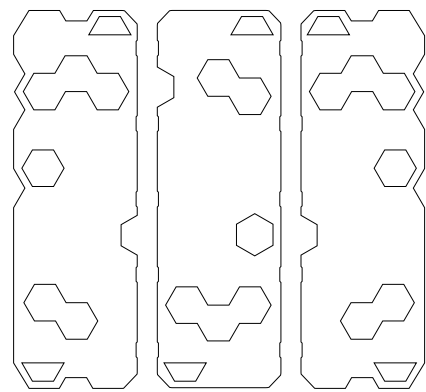

Hex

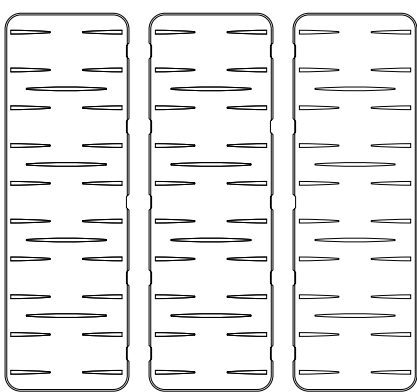

Wamika

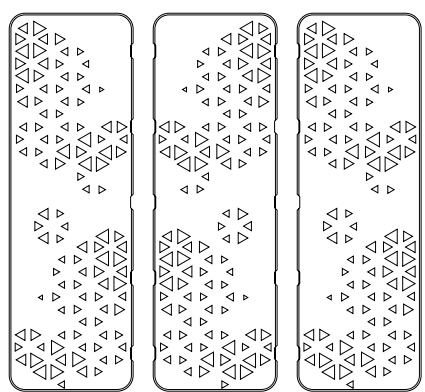

Prose

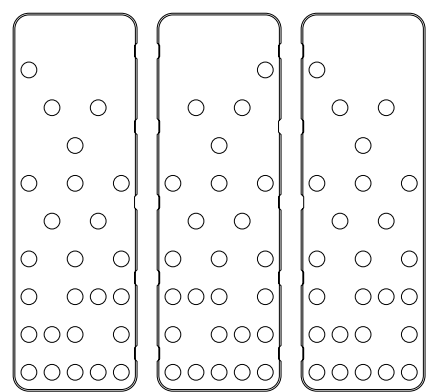

Punto

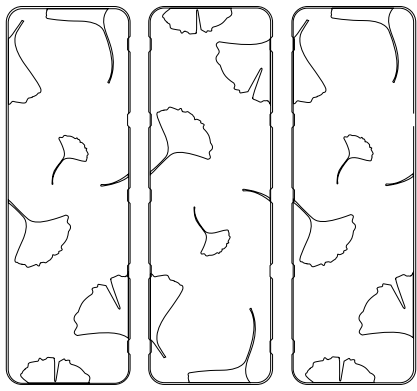

Ginkgo

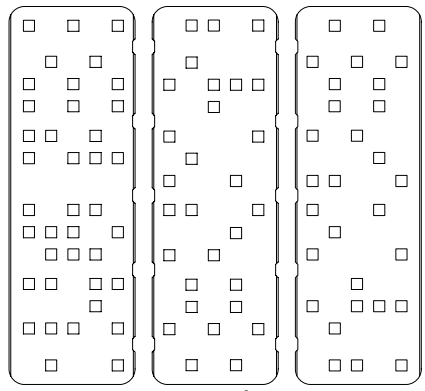

Pixel



110. Zintra Desk Wrap in Cadet, shown with Clamshell Clamp Small

# Zintra Desk Wrap



Zintra Desk Wrap in Pewter, shown with Clamshell Clamp Small

Carefully placed slice cuts allow Zintra to become flexible and wrap around the corners of a desk. When wrapped, the slice cuts reveal a defining pattern. Use Desk Wraps as a screen or modesty panel to add privacy and acoustic benefits.



Zintra Desk Wrap in Ercu, shown with Clamshell Clamp Small

## DESK WRAP SPECIFICATIONS

Dimensions: (See page 113)

Colors: Available in all 24 colors (See page 11)

Finishes: Clamshell – White  
L-Bracket – White

NRC Rating: 0.90 (See pages 8-9)

Aw Rating: 0.95 (See pages 8-9)

Notes: Not available as Zintra Patterns

Clamshell Clamps (for Screen) or L-Bracket (for Modesty) included

For complete specification and installation information, visit [zintracoustic.com](http://zintracoustic.com)



Top view

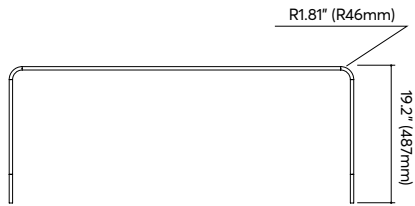

Front view

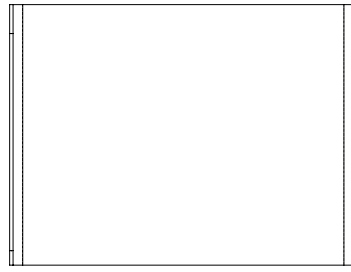

Side view

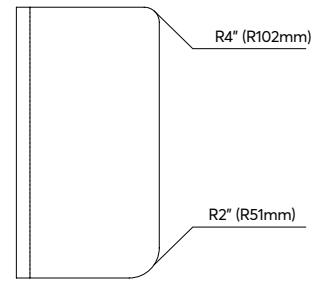

\* Suits metric desk size

### Desk Wrap Screen

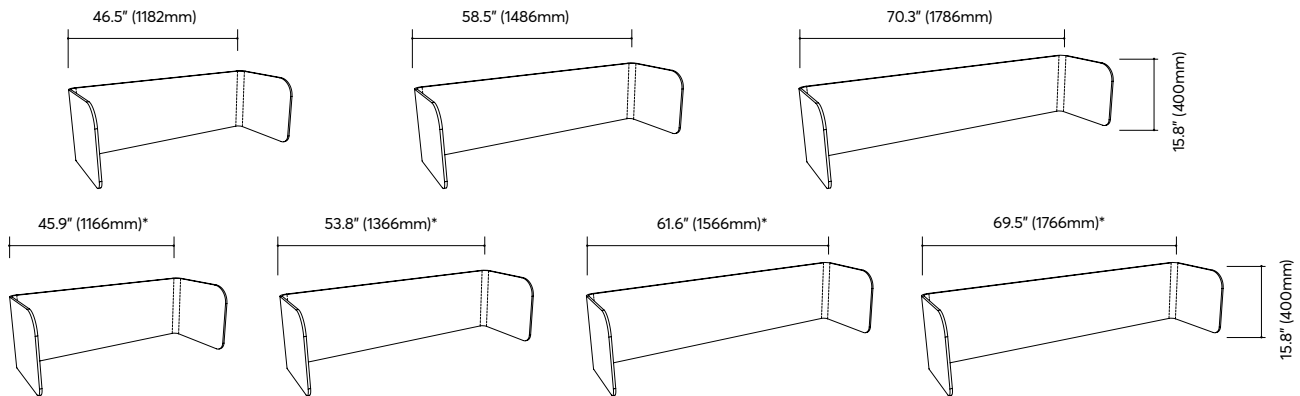

### Desk Wrap Screen (smaller dimension) or Desk Wrap Modesty (larger dimension)

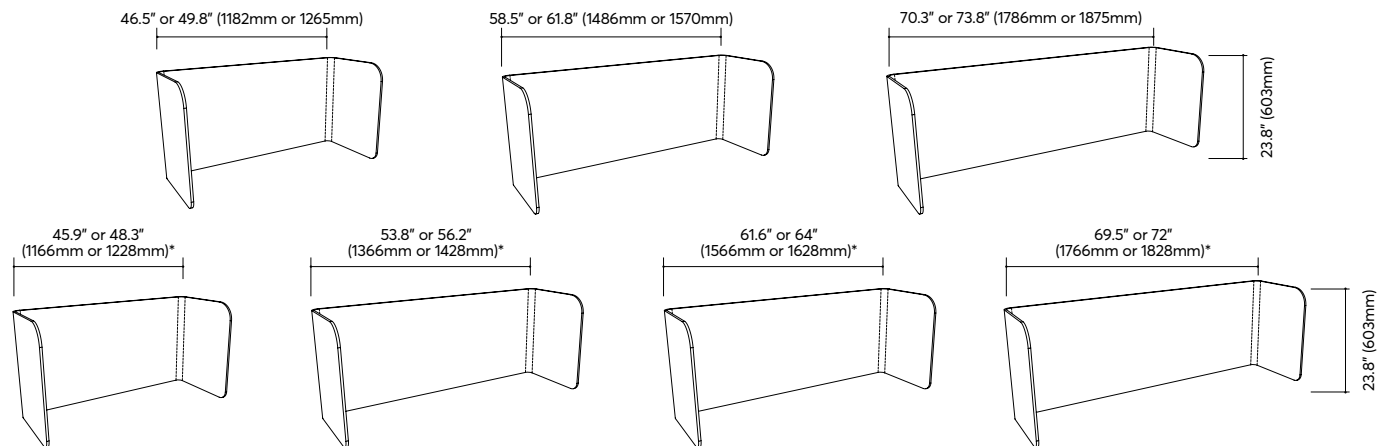

### Desk Wrap Modesty

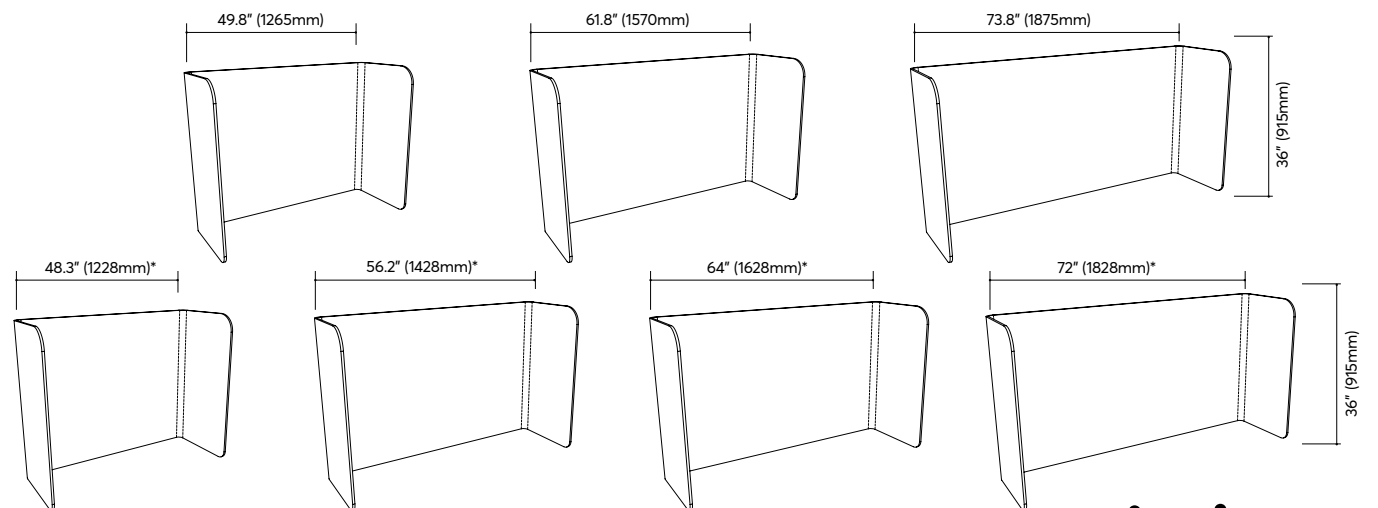



114. Zintra Desk Dividers Prose in Smoke and Cobalt

# Zintra Desk Dividers



Zintra Desk Divider Bhushan in Linen and Ecr

An easy to use and install solution when a little bit of privacy is needed. Simply slide the Desk Divider over the edge of the work surface and tighten the knob. Use Desk Dividers for a permanent division or as needed. Completely customizable to fit almost any work surface.



Zintra Desk Divider Pixel in Bark on Linen

## DESK DIVIDERS SPECIFICATIONS

Dimensions: Two 1/2" (12mm) sheets laminated together

Colors: Available in all 24 colors (See page 117)

NRC Rating: 0.90 (See pages 8-9)

Aw Rating: 0.95 (See pages 8-9)

Notes: Pattern may be specified to one side or both  
Hardware included

For complete specification and installation information, visit [zintraacoustic.com](http://zintraacoustic.com)

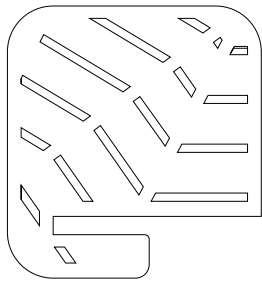
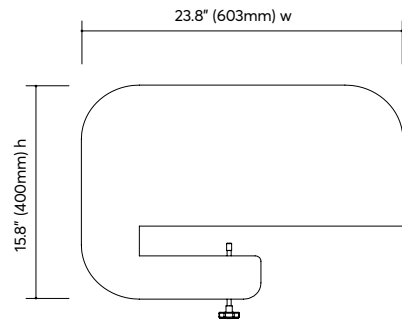
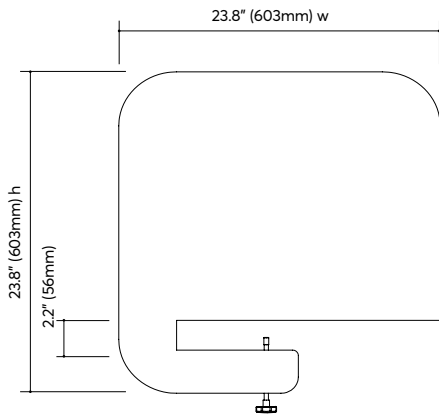

Bhushan

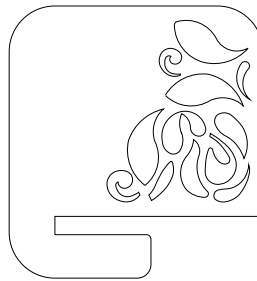

Kerala

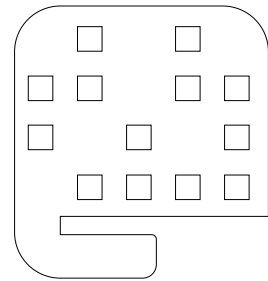

Pixel

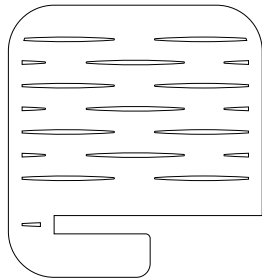

Wamika

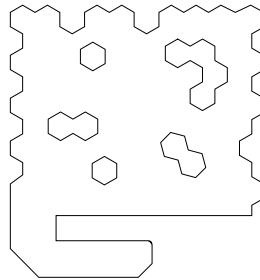

Hex

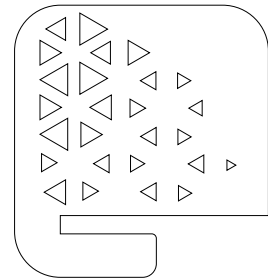

Prose

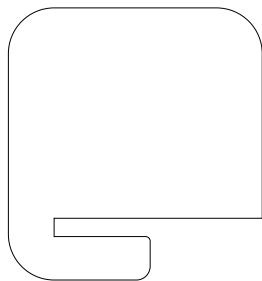

Plain

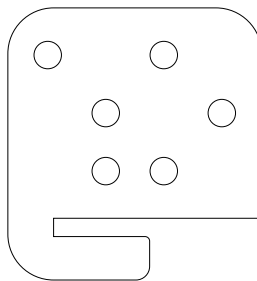

Punto

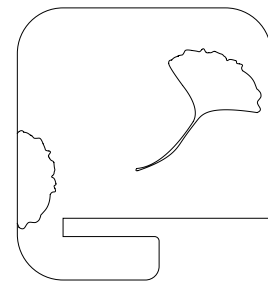

Ginkgo



118. Zintra Desk Screens Prose in Smoke and Cobalt, shown with Clamshell Clamp Large

# Zintra Desk Screen



Zintra Desk Screen Pixel in Chambray on Sky, shown with Clamshell Clamp Large

Zintra Desk Screens are ideal for open work spaces that need more privacy. These surface mounted partitions sit secure in place while capturing unwanted noise and adding color and design. Completely customizable to fit almost any work surface.



Zintra Desk Screen Punto in Slate on Grass, shown with Clamshell Clamp Large

## DESK SCREEN SPECIFICATIONS

- Dimensions: (See page 121)  
Thickness: 0.5" (12mm) Single Layer or 1" (24mm) – (two layers x 1/2" (12mm) material)  
Colors: Available in all 24 colors (See page 11)  
Finishes: Clamshell – White  
NRC Rating: 0.90 (See pages 8-9)  
Aw Rating: 0.95 (See pages 8-9)  
Notes: Pattern may be specified on one side or both  
Hardware included

For complete specification and installation information, visit [zintracoustic.com](http://zintracoustic.com)



**\* Suits metric desk size**

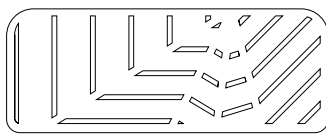
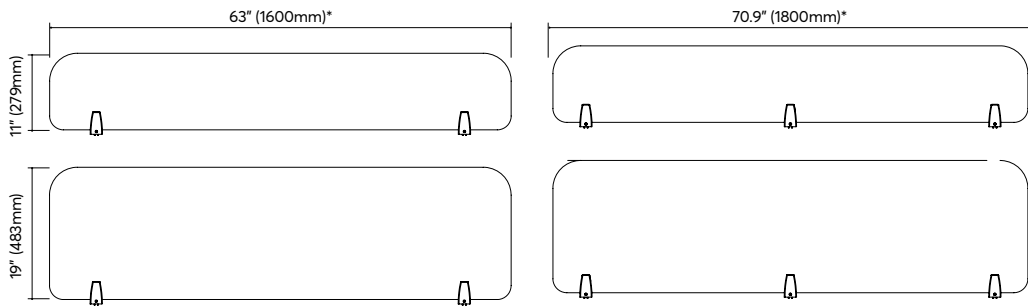
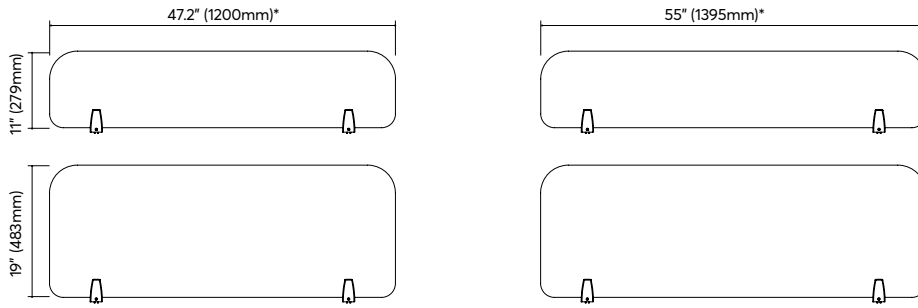
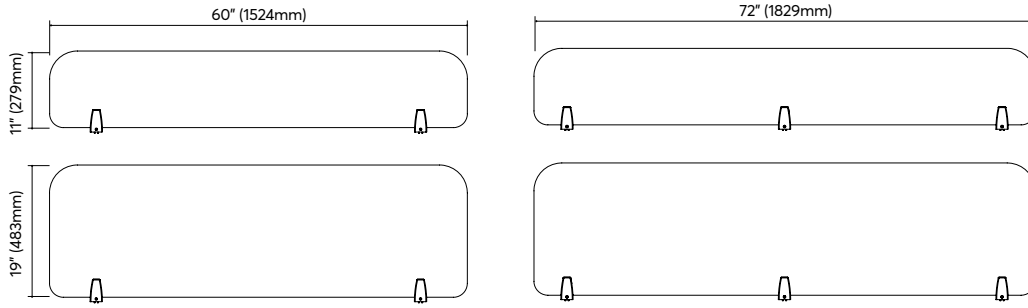
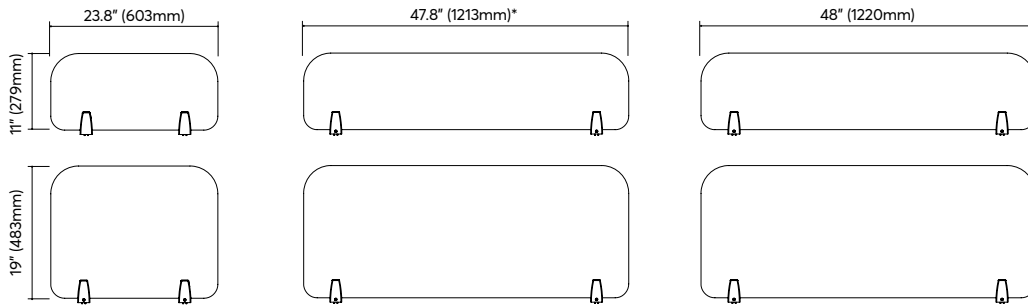

**Bhushan**

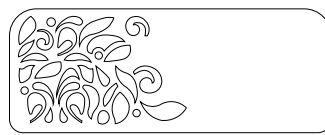

**Kerala**

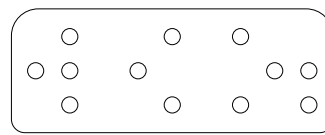

**Punto**

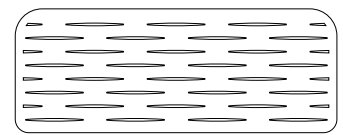

**Wamika**

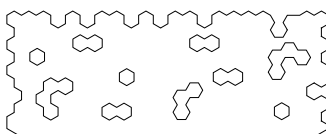

**Hex**

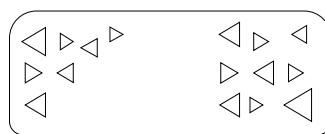

**Prose**

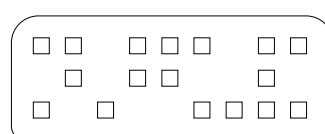

**Pixel**

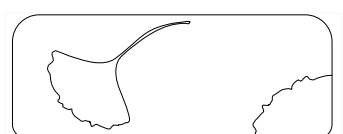

**Ginkgo**



122. Zintra Desk Modesty Punto in Greige on Linen, shown with L-Bracket

# Zintra Desk Modesty



Zintra Desk Modesty Prose in Grass and Pewter

Provide privacy above and below the desk with these edge mounted screens. Available in a variety of standard patterns and sizes, the Desk Modesty is also completely customizable.



Zintra Desk Modesty Bhushan in Smoke on Slate

## DESK MODESTY SPECIFICATIONS

Dimensions: Available in 1" (24mm) – 2 x 1/2" (12mm) laminated (See page 125)

Colors: Available in all 24 colors (See page 11)

Finishes: L-Bracket – White

NRC Rating: 0.90 (See pages 8-9)

Aw Rating: 0.95 (See pages 8-9)

Notes: Pattern may be specified on one side or both  
Hardware included

For complete specification and installation information, visit [zintraacoustic.com](http://zintraacoustic.com)

**\* Suits metric desk size**

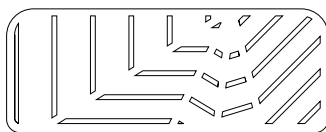
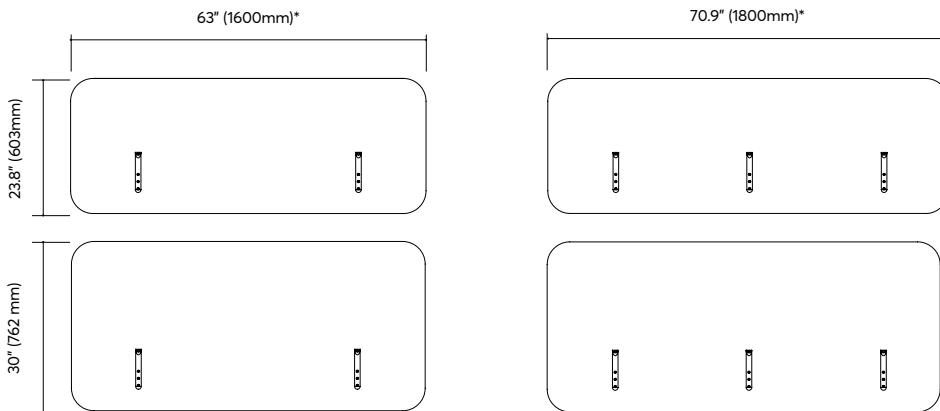
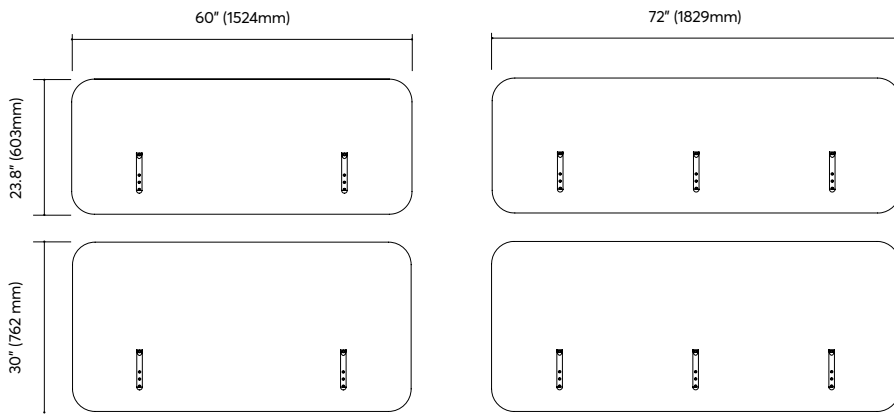
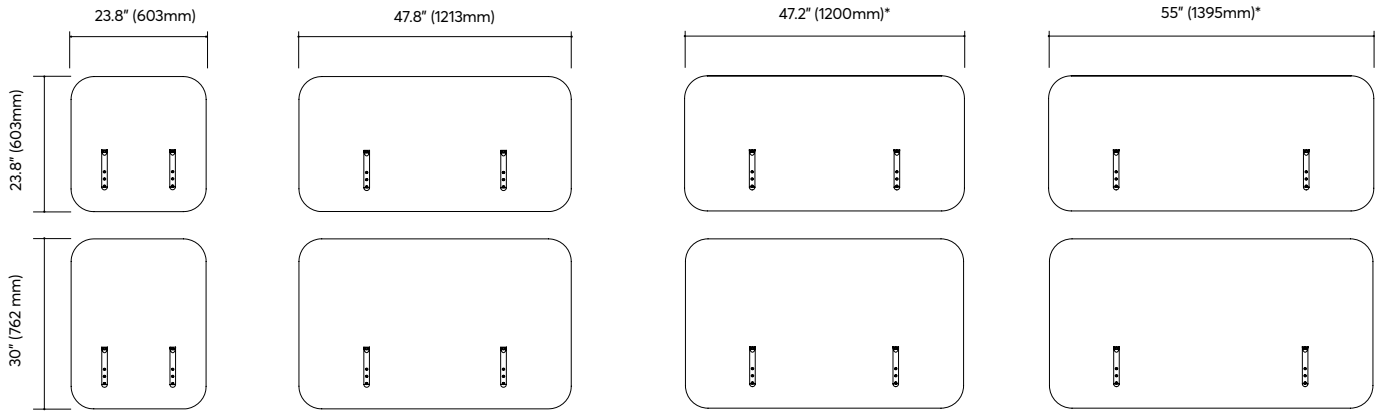

**Bhushan**



**Kerala**

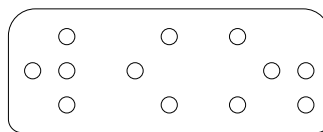

**Punto**

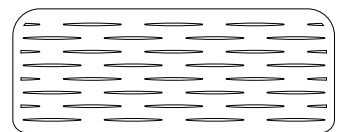

**Wamika**

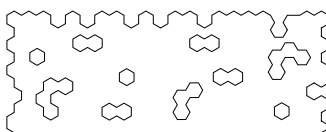

**Hex**

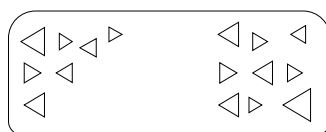

**Prose**

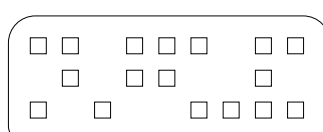

**Pixel**

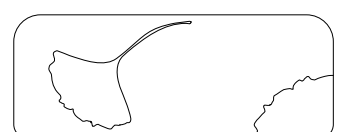

**Ginkgo**

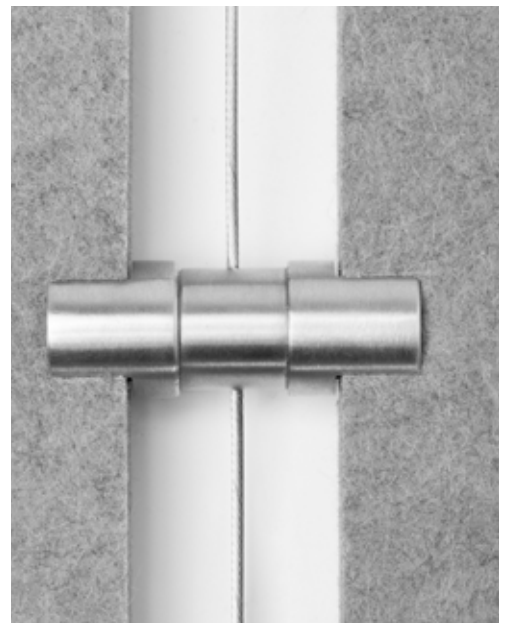
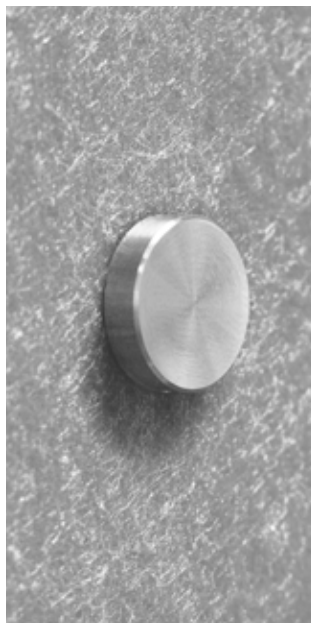

# Hardware





### ADJUSTABLE CABLE KIT

Dimensions: Steel Cable North America / Asia – 5' (1524mm)  
Europe – 6 1/2' (2000mm)

Finish: Silver

Notes: Kit includes Steel Cable, Barrel Fixing, Anchor Bolt & Adjustable Toggle

Used With: Baffles – Individual & Systems, Clouds, Connect & Shapes

---



### CABLE SIDE GRIPPER DOUBLE

Finish: Brushed Stainless Steel

Notes: Requires Floor to Ceiling Cable Kit (sold separately)

Compatible with Zintra 1/2" (12mm) Sheets only

Used With: Floor to Ceiling

---



### CABLE SIDE GRIPPER SINGLE

Finish: Brushed Stainless Steel

Notes: Requires Floor to Ceiling Cable Kit (sold separately)

Compatible with Zintra 1/2" (12mm) Panels only

Used With: Floor to Ceiling

---



### CABLE STANDOFF

Finish: Brushed Stainless Steel

Notes: Requires Floor to Ceiling Cable Kit (sold separately)

Compatible with Zintra 1/2" (12mm) Sheets only

Used With: Floor to Ceiling

---



### CLAMSHELL CLAMP LARGE

Color: White

Notes: Compatible with 1" (24mm) Zintra Acoustic Solutions

Used With: Desk Screen

---



### CLAMSHELL CLAMP SMALL

Color: White

Notes: Compatible with 1/2" (12mm) Zintra Acoustic Solutions

Used With: Desk Screen & Desk Wrap Screen

---



### DOUBLE SLIDING TRACK

Dimensions: North America / Asia – 1.4" (35 mm) x 2.2" (56mm) x 96" (2438mm)  
Europe - 1.6" (40mm) x 1.4" (35mm) X 110" (2800mm)

Finish: Satin Aluminium

Used With: Sliding Track





### FLOOR TO CEILING CABLE KIT

Dimensions: 13'1" (4000mm) Cables  
 Finish: Silver  
 Notes: Requires Side Gripper Single, Side Gripper Double or Cable Standoff (sold separately)  
 Used With: Floor to Ceiling



### L – BRACKET

Finish: White  
 Notes: Compatible with 1" (24mm) thick Zintra acoustic solutions  
 Used With: Desk Modesty & Desk Wrap Modesty



### ROLLER KIT

Finish: Stainless Silver  
 Notes: Minimum of (2) Roller Kit required for panels 48" (1220mm) wide or less  
 (3) Roller Kit required for panels wider than 48" (1220mm)  
 Requires Double Sliding Track (sold separately)  
 Kit includes roller and fixing plate  
 Used With: Sliding Track



### S-HOOK

Finish: Silver  
 Notes: Requires Twist Clip – Loop or Twist Clip – Swivel  
 Used With: Individual Baffle – Hook



### STANDOFF – 1" (25MM)

Finish: Brushed Stainless Steel  
 Notes: Compatible with Zintra Acoustic Solutions up to 1" (24mm) thick  
 Used With: Sheets, Patterns & Etch



### STANDOFF – 1.75" (45MM)

Finish: Brushed Stainless Steel  
 Notes: Compatible with Zintra Acoustic Solutions up to 1" (24mm) thick  
 Used With: Sheets, Patterns & Etch



### STANDOFF – 2.5" (65MM)

Finish: Brushed Stainless Steel  
 Notes: Compatible with Zintra Acoustic Solutions up to 1" (24mm) thick  
 Used With: Sheets, Patterns & Etch



### **SQUARE TUBE 1" (25MM) X 1" (25MM)**

Dimensions: 1" (25mm) x 1" (25mm) x 110" (2795mm)

Finish: Satin Aluminum or Black

Used With: Baffles & Blades

---



### **TWIST CLIP LOOP**

Finish: White

Notes: North America / Asia – Compatible with 15"/16" ceiling grid

Europe – Compatible with T24 ceiling grid

Requires S-Hook (sold separately)

Used With: Baffle Individual

---



### **TWIST CLIP THREADED**

Finish: Silver

Notes: North America / Asia – Compatible with 15"/16" ceiling grid

Europe – Compatible with T24 ceiling grid

Requires Adjustable Cable Kit (sold separately)

Used With: Baffle Systems, Baffles Individual, Clouds & Shapes

---



### **TWIST CLIP SWIVEL**

Finish: Clear

Notes: Not available in Europe

Compatible with 15"/16" ceiling grids.

Requires S-Hook (sold separately)

Used With: Individual Baffle – Hook

---



### **U-CHANNEL**

Dimensions: North America / Asia – 0.5" (12mm) x 0.5" (12mm) x 108" (2745mm)

Europe – 15mm x 15mm x 2800mm

Finish: Satin Aluminum

Notes: Compatible with 1/2" (12mm) thick Zintra Acoustic Solutions

Used With: Baffles Individual

---



### **Z-CLIPS**

Dimensions: 1.5" (38mm) or 36" (914mm)

Finish: Aluminium mill finish

Notes: Sold as pairs

Used With: Sheets, Etch & Patterns

---

## TRIMS



---

### J-TRIM

Dimensions: North America / Asia – 0.5" (12mm) x 1" (24mm) x 110" (2795mm)  
Europe – 17mm x 27mm x 2800mm  
Finish: Satin Aluminum  
Notes: Compatible with Zintra 1/2" (12mm) Sheets only  
Used With: Sheets & Etch

---



---

### L-ANGLE 1" (25MM) X 1" (25MM)

Dimensions: 25mm x 25mm x 2800mm  
Finish: Satin Aluminum  
Used With: Sheets, Etch & Shapes

---



---

### L-ANGLE 1/2" (12MM) X 1" (25MM)

Dimensions: North America / Asia – 1" (25mm) x 0.5" (12mm) x 110" (2800mm)  
Europe – 1" (25mm) x 0.6" (15mm) x 110" (2800mm)  
Finish: Satin Aluminum  
Used With: Sheets & Etch

---



---

### RADIUS TRIM

Dimensions: 1" (24mm) x 1" (24mm) x 110" (2795mm)  
Finish: Satin Aluminum  
Notes: Not available in Europe  
Compatible with Zintra 1/2" Sheets only.  
Custom finishes available for an additional fee.  
Used With: Sheets & Etch

---



[www.goodrichglobal.com](http://www.goodrichglobal.com) | [info@goodrichglobal.com](mailto:info@goodrichglobal.com)

 Goodrich.Global.Singapore |  goodrich\_global |  GoodrichGlobal |  GoodrichChina  
 GoodrichGlobal |  goodrichglobal |  GoodrichHQ |  Goodrich\_Global

SINGAPORE (HQ) | CHINA | HONG KONG (CHINA) | INDIA | INDONESIA | MALAYSIA  
MYANMAR | PHILIPPINES | THAILAND | UNITED ARAB EMIRATES | VIETNAM

Copyright © 2021 Goodrich Global. All rights reserved.

